



INTERNATIONAL TELECOMMUNICATION UNION

**ITU-T**

TELECOMMUNICATION  
STANDARDIZATION SECTOR  
OF ITU

**I.363.1**

(08/96)

SERIES I: INTEGRATED SERVICES DIGITAL  
NETWORK

Overall network aspects and functions – Protocol layer  
requirements

---

**B-ISDN ATM Adaptation Layer specification:  
Type 1 AAL**

ITU-T Recommendation I.363.1

(Previously CCITT Recommendation)

---

ITU-T I-SERIES RECOMMENDATIONS  
**INTEGRATED SERVICES DIGITAL NETWORK**

GENERAL STRUCTURE	I.100–I.199
Terminology	I.110–I.119
Description of ISDNs	I.120–I.129
General modelling methods	I.130–I.139
Telecommunication network and service attributes	I.140–I.149
General description of asynchronous transfer mode	I.150–I.199
SERVICE CAPABILITIES	I.200–I.299
Scope	I.200–I.209
General aspects of services in ISDN	I.210–I.219
Common aspects of services in the ISDN	I.220–I.229
Bearer services supported by an ISDN	I.230–I.239
Teleservices supported by an ISDN	I.240–I.249
Supplementary services in ISDN	I.250–I.299
OVERALL NETWORK ASPECTS AND FUNCTIONS	I.300–I.399
Network functional principles	I.310–I.319
Reference models	I.320–I.329
Numbering, addressing and routing	I.330–I.339
Connection types	I.340–I.349
Performance objectives	I.350–I.359
<b>Protocol layer requirements</b>	<b>I.360–I.369</b>
General network requirements and functions	I.370–I.399
ISDN USER-NETWORK INTERFACES	I.400–I.499
Application of I-series Recommendations to ISDN user-network interfaces	I.420–I.429
Layer 1 Recommendations	I.430–I.439
Layer 2 Recommendations	I.440–I.449
Layer 3 Recommendations	I.450–I.459
Multiplexing, rate adaption and support of existing interfaces	I.460–I.469
Aspects of ISDN affecting terminal requirements	I.470–I.499
INTERNETWORK INTERFACES	I.500–I.599
MAINTENANCE PRINCIPLES	I.600–I.699
B-ISDN EQUIPMENT ASPECTS	I.700–I.799
ATM equipment	I.730–I.749
Management of ATM equipment	I.750–I.799

*For further details, please refer to ITU-T List of Recommendations.*

## **ITU-T RECOMMENDATION I.363.1**

### **B-ISDN ATM ADAPTATION LAYER SPECIFICATION: TYPE 1 AAL**

#### **Source**

ITU-T Recommendation I.363.1 was prepared by ITU-T Study Group 13 (1993-1996) and was approved under the WTSC Resolution No. 1 procedure on the 27th of August 1996.

## FOREWORD

ITU (International Telecommunication Union) is the United Nations Specialized Agency in the field of telecommunications. The ITU Telecommunication Standardization Sector (ITU-T) is a permanent organ of the ITU. The ITU-T is responsible for studying technical, operating and tariff questions and issuing Recommendations on them with a view to standardizing telecommunications on a worldwide basis.

The World Telecommunication Standardization Conference (WTSC), which meets every four years, establishes the topics for study by the ITU-T Study Groups which, in their turn, produce Recommendations on these topics.

The approval of Recommendations by the Members of the ITU-T is covered by the procedure laid down in WTSC Resolution No. 1.

In some areas of information technology which fall within ITU-T's purview, the necessary standards are prepared on a collaborative basis with ISO and IEC.

## NOTE

In this Recommendation, the expression "Administration" is used for conciseness to indicate both a telecommunication administration and a recognized operating agency.

## INTELLECTUAL PROPERTY RIGHTS

The ITU draws attention to the possibility that the practice or implementation of this Recommendation may involve the use of a claimed Intellectual Property Right. The ITU takes no position concerning the evidence, validity or applicability of claimed Intellectual Property Rights, whether asserted by ITU members or others outside of the Recommendation development process.

As of the date of approval of this Recommendation, the ITU had/had not received notice of intellectual property, protected by patents, which may be required to implement this Recommendation. However, implementors are cautioned that this may not represent the latest information and are therefore strongly urged to consult the TSB patent database.

© ITU 1997

All rights reserved. No part of this publication may be reproduced or utilized in any form or by any means, electronic or mechanical, including photocopying and microfilm, without permission in writing from the ITU.

## CONTENTS

	<b>Page</b>
1 Introduction.....	1
1.1 Scope of the Recommendation .....	1
2 AAL type 1.....	1
2.1 Services provided by AAL type 1.....	1
2.1.1 Definitions .....	1
2.1.2 Primitives between AAL type 1 and the AAL user.....	1
2.1.3 Information flow across the ATM-AAL boundary.....	3
2.1.4 Primitives between the SAR sublayer and the CS.....	3
2.2 Interaction with the management and control planes.....	4
2.2.1 Management plane.....	4
2.2.2 Control plane .....	4
2.3 Functions of AAL type 1 .....	4
2.4 Segmentation and Reassembly (SAR) sublayer.....	5
2.4.1 Functions of the SAR sublayer .....	5
2.4.2 SAR protocol .....	5
2.5 Convergence Sublayer (CS).....	8
2.5.1 Functions of the CS .....	8
2.5.2 Convergence Sublayer (CS) protocol.....	11
Annex A – Alphabetical list of abbreviations.....	24
Annex B – Data unit naming convention.....	25
Annex C – Encoding and information transfer principles .....	26
C.1 Cell payload field encoding .....	26
C.2 AAL user information transfer.....	27
Appendix I – Functional model and SDL of AAL type 1.....	28
I.1 Functional model of the SAR .....	28
I.2 SDL of the SAR.....	30
Appendix II – Informative and example parameters for AAL type 1 protocol.....	32
II.1 Circuit transport .....	32
II.1.1 Transport of digital channel supported by 64 kbit/s-based ISDN.....	32
II.1.2 Transport of G.702 PDH circuit .....	32
II.1.3 Transport of G.709 SDH circuit .....	33
II.2 Video signal transport.....	33
II.3 Voiceband signal transport .....	34

Appendix III – Informative and example operations for handling of lost/misinserted cells and for maintaining bit count integrity .....	35
III.1 Introduction.....	35
III.2 Sequence number processing.....	35
III.2.1 General.....	35
III.2.2 Indications from the SAR sublayer.....	35
III.2.3 Capabilities of the algorithm .....	36
III.2.4 The algorithms .....	36
III.3 Mechanisms to maintain bit-count integrity and basic handling of lost/misinserted cells .....	39
III.3.1 Buffer-fill level monitoring .....	40
III.3.2 Cell Arrival Monitoring.....	40

## **Recommendation I.363.1**

### **B-ISDN ATM ADAPTATION LAYER SPECIFICATION: TYPE 1 AAL**

*(Geneva, 1996)*

## **1 Introduction**

The ATM Adaptation Layer (AAL) enhances the service provided by the ATM layer to support functions required by the next higher layer. The AAL performs functions required by the user, control and management planes and supports the mapping between the ATM layer and the next higher layer. The functions performed in the AAL depend upon the higher layer requirements.

The AAL supports multiple protocols to fit the needs of the different AAL service users. The service provided by the AAL type 1 to the higher layer and the functions performed are specified in this Recommendation.

Abbreviations used in this Recommendation are listed in Annex A. Details of the data unit naming convention used in this Recommendation can be found in Annex B.

### **1.1 Scope of the Recommendation**

This Recommendation describes the interactions between the AAL type 1 and the next higher layer, and the AAL type 1 and the ATM layer, as well as AAL type 1 peer-to-peer operations.

Different combinations of SAR (Segmentation and Reassembly) sublayer and CSs (Convergence Sublayers) provide different Service Access Points (SAPs) to the layer above the AAL.

## **2 AAL type 1**

### **2.1 Services provided by AAL type 1**

#### **2.1.1 Definitions**

The layer services provided by AAL type 1 to the AAL user are:

- transfer of service data units with a constant source bit rate and the delivery of them with the same bit rate;
- transfer of timing information between source and destination;
- transfer of structure information between source and destination;
- indication, if needed, of lost or errored information which is not recovered by AAL type 1.

#### **2.1.2 Primitives between AAL type 1 and the AAL user**

##### **2.1.2.1 General**

At the AAL-SAP, the following primitives will be used between the AAL type 1 and the AAL user:

- From an AAL user to the AAL,  
AAL-UNITDATA Request;
- From the AAL to an AAL user,  
AAL-UNITDATA Indication.

An AAL-UNITDATA request primitive at the local AAL-SAP results in an AAL-UNITDATA indication primitive at its peer AAL-SAP.

### **2.1.2.2 Definition of primitives**

#### **2.1.2.2.1 AAL-UNITDATA request**

AAL-UNITDATA request (DATA [mandatory],  
STRUCTURE [optional])

The AAL-UNITDATA request primitive requests the transfer of the AAL-SDU, i.e. contents of the DATA parameter, from the local AAL entity to its peer entity. The length of the AAL-SDU is constant and the time interval between two consecutive primitives is constant. These two constants are a function of the AAL service provided to the AAL user.

#### **2.1.2.2.2 AAL-UNITDATA indication**

AAL-UNITDATA indication (DATA [mandatory],  
STRUCTURE [optional],  
STATUS [optional])

An AAL user is notified by the AAL that the AAL-SDU, i.e. contents of the DATA parameter, from its peer are available. The length of the AAL-SDU should be constant and the time interval between two consecutive primitives should be constant. These two constants are a function of the AAL service provided to the AAL user.

### **2.1.2.3 Definition of parameters**

#### **2.1.2.3.1 DATA parameter**

The DATA parameter carries the AAL-SDU to be sent or delivered. Its size depends on the specific AAL layer service used, and is described in 2.5.1.1 a) to 2.5.1.4 a).

#### **2.1.2.3.2 STRUCTURE parameter (optional use)**

The STRUCTURE parameter can be used when the user data stream to be transferred to the peer AAL entity is organized into groups of bits. The length of the structured block is fixed for each instance of the AAL service. The length is an integer multiple of 8 bits. An example of the use of this parameter is to support circuit mode bearer services of the 64 kbit/s-based ISDN. The two values of the STRUCTURE parameter are:

START, and  
CONTINUATION.

The value START is used when the DATA is the first part of a structured block which can be composed of consecutive DATA. In other cases, the structure parameter is set to CONTINUATION. The use of the STRUCTURE parameter depends on the type of AAL service provided. The use of this parameter is agreed prior to or at the connection establishment between the AAL user and the AAL.



### **2.1.2.3.3 STATUS parameter (optional use)**

The STATUS parameter identifies that the DATA is judged to be non-errored or errored. The STATUS parameter has two values:

VALID, and

INVALID.

The INVALID status could also imply that the DATA is a dummy value. The use of the STATUS parameter and the choice of dummy value depend on the type of AAL service provided. The use of this parameter is agreed prior to or at the connection establishment between the AAL user and the AAL.

### **2.1.3 Information flow across the ATM-AAL boundary**

Recommendation I.361 describes the primitives exchanged between the ATM layer and the AAL. This subclause describes the usage of these primitives for AAL type 1.

The AAL receives from the ATM layer the information in the form of a 48-octet ATM Service Data Unit (ATM-SDU). The AAL passes to the ATM layer information in the form of a 48-octet ATM-SDU.

The submitted CLP (Cell Loss Priority) in the request primitive is set to the high priority by the AAL transmitter. The value of the receive loss priority in the indication primitive is ignored by the AAL receiver.

The AUU (ATM-User-to-ATM-User) parameter is set to "0" in the request primitive. Future procedures may require that the AUU parameter can be set to "0" or "1". Such usage is reserved for future standardization.

The congestion indication is ignored by the AAL receiver.

The encoding principles for mapping information between the ATM layer and AAL type 1 are given in Annex C.

### **2.1.4 Primitives between the SAR sublayer and the CS**

#### **2.1.4.1 General**

These primitives model the exchange of information between the SAR sublayer and the Convergence Sublayer (CS). As there exists no Service Access Point (SAP) between the sublayers of the AAL type 1, the primitives are called "invoke" and "signal" instead of the conventional "request" and "indication" to highlight the absence of the SAP. Functional model and SDL of AAL type 1 is given in Appendix I.

#### **2.1.4.2 SAR-UNITDATA invoke**

SAR-UNITDATA invoke at the AAL type 1 transmitter has the following parameters:

- Interface data: This parameter specifies the interface data unit passed from the CS to the SAR entity. The interface data is 47 octets, and represents a SAR-PDU payload.
- CSI: The Convergence Sublayer Indication (CSI), either "0" or "1", is passed from the CS to the SAR entity.
- Sequence count: The sequence count value is passed from the CS to the SAR entity. The value of sequence count starts with 0, is incremented sequentially and is numbered modulo 8.

### **2.1.4.3 SAR-UNITDATA signal**

SAR-UNITDATA signal at the AAL type 1 receiver has the following parameters:

- Interface data: This parameter specifies the interface data unit passed from the SAR to the CS entity. The interface data is 47 octets, and represents a SAR-PDU payload.
- CSI: The CSI is passed from the SAR to CS entity, regardless of the check status (valid or invalid).
- Sequence count: The sequence count value is passed from the SAR to CS entity, regardless of the check status (valid or invalid).
- Check status: This parameter specifies the status of the sequence count and CSI, and has the value of either valid or invalid.

## **2.2 Interaction with the management and control planes**

### **2.2.1 Management plane**

The following indications may be passed from the user plane to the management plane:

- errors in the transmission of user information;
- lost or misinserted cells (further study is required on whether it is necessary to distinguish between lost and misinserted cells for management purposes);
- cells with errored AAL Protocol Control Information (AAL-PCI) (further study is required to determine if this indication is necessary for layer services supported by this AAL type);
- loss of timing and synchronization;
- buffer underflow and overflow.

### **2.2.2 Control plane**

For further study.

## **2.3 Functions of AAL type 1**

The following functions may be performed in the AAL type 1 in order to enhance the ATM layer service:

- a) segmentation and reassembly of user information;
- b) blocking and deblocking of user information;
- c) handling of cell delay variation;
- d) handling of cell payload assembly delay;
- e) handling of lost or misinserted cells;
- f) source clock frequency recovery at the receiver;
- g) recovery of the source data structure at the receiver;
- h) monitoring of AAL-PCI for bit errors;
- i) handling of AAL-PCI bit errors;
- j) monitoring of user information field for bit errors and possible corrective action.

Other functions are for further study.

NOTE – For some AAL users, the end-to-end QOS may be monitored. This may be achieved by calculating a CRC for the CS-PDU payload, carried in one or more cells, and transmitting the CRC results in the CS-PDU or by the use of OAM cells. Further study is required.

## 2.4 Segmentation and Reassembly (SAR) sublayer

### 2.4.1 Functions of the SAR sublayer

The SAR sublayer functions are performed on an ATM-SDU basis.

a) *Mapping between CS-PDU and SAR-PDU*

The SAR sublayer at the transmitting end accepts a 47-octet block of interface data from the Convergence Sublayer (CS), and then prepends a one-octet SAR-PDU header to each block to form the SAR-PDU.

The SAR sublayer at the receiving end receives the 48-octet block of data from the ATM layer, and then separates the SAR-PDU header. The 47-octet block of SAR-PDU payload (interface data) is passed to the CS.

b) *Existence of CS function*

The SAR sublayer has the capability to indicate the existence of a CS function. Associated with each 47-octet SAR-PDU payload, it receives this indication (CSI) from the CS and conveys it to the peer CS entity.

c) *Sequence numbering*

Associated with each SAR-PDU payload, the SAR sublayer receives a sequence count value from the CS. At the receiving end, it passes the sequence count value to the CS. The CS may use these sequence count values to detect lost or misinserted SAR-PDU payloads (corresponding to lost or misinserted ATM cells).

d) *Error protection*

The SAR sublayer protects the sequence count value and the CS indication against bit errors. It informs the receiving CS by the value of check status whether the sequence count value and/or the CS indication are errored.

### 2.4.2 SAR protocol

The SAR-PDU header together with the 47 octets of the SAR-PDU payload comprises the 48-octet ATM-SDU (cell information field). The size and positions of the fields in the SAR-PDU are given in Figure 1.

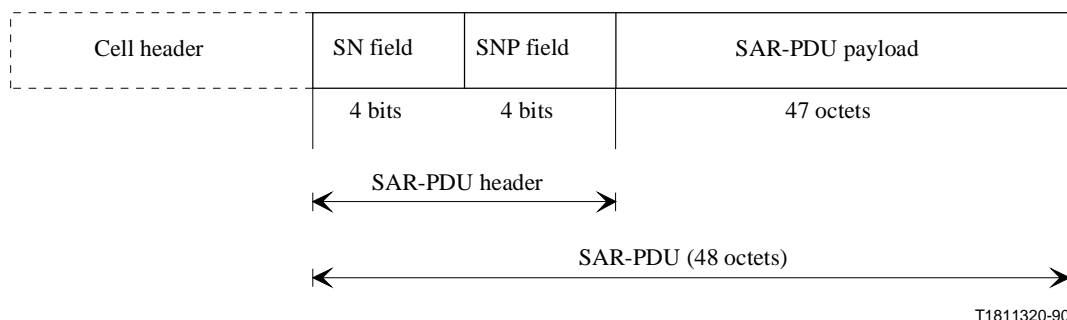
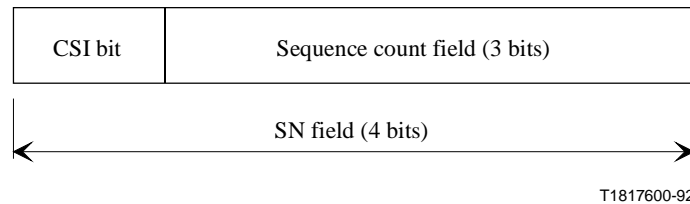

Figure 1/I.363.1 – SAR-PDU format of AAL type 1

#### 2.4.2.1 Sequence Number (SN) field

The SN field is divided into two subfields as shown in Figure 2. The sequence count field carries the sequence count value provided by the Convergence Sublayer (CS). The CSI bit carries the CS indication provided by the CS. The default value of the CSI bit is "0".

The least significant bit of the sequence count value is right justified in the sequence count field.

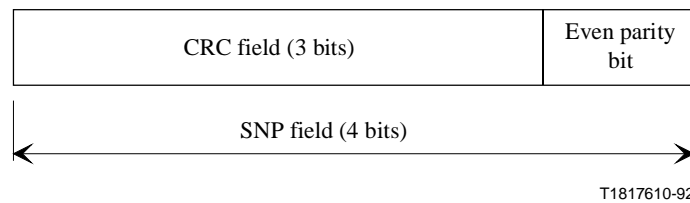

**Figure 2/I.363.1 – Sequence Number (SN) field format**

#### 2.4.2.2 Sequence Number Protection (SNP) field

The SNP field provides error detection and correction capabilities over the SAR-PDU header. The format of this field is given in Figure 3. A two-step approach is used for the protection:

- 1) The Sequence Number (SN) field is protected by a 3-bit CRC code.
- 2) The resulting 7-bit codeword is protected by an even parity bit; i.e. the parity bit is set such that the 8-bit SAR-PDU header has an even parity.



**Figure 3/I.363.1 – SNP field format**

The receiver is capable of either single-bit error correction or multiple-bit error detection.

a) *Operations at transmitting end*

The transmitter computes the CRC value across the first 4 bits of the SAR-PDU header and inserts the result in the CRC field.

The notation used to describe the CRC is based on the property of cyclic codes. The elements of an  $n$ -element codeword are thus the coefficients of a polynomial of order  $n - 1$ . In this application, these coefficients can have the value 0 or 1 and the polynomial operations are performed using modulo 2 operations. For example, a code vector such as 1011 can be represented by the polynomial  $P(x) = x^3 + x + 1$ . The polynomial representing the content of the SN field is generated using the first bit of the SN field as the coefficient of the highest order term.

The CRC field consists of three bits. It shall contain the remainder of the division (modulo 2) by the generator polynomial  $x^3 + x + 1$  of the product  $x^3$  multiplied by the content of the SN field. The coefficient of the  $x^2$  term in the remainder polynomial is left justified in the CRC field.

After completing the above operations, the transmitter inserts the even parity bit.

b) *Operations at receiving end*

The receiver has two different modes of operation: correction mode and detection mode. These modes are related as shown in Figure 4. The default mode is the correction mode, which provides for single-bit error correction. At initialization, the receiver is set up in this default mode.

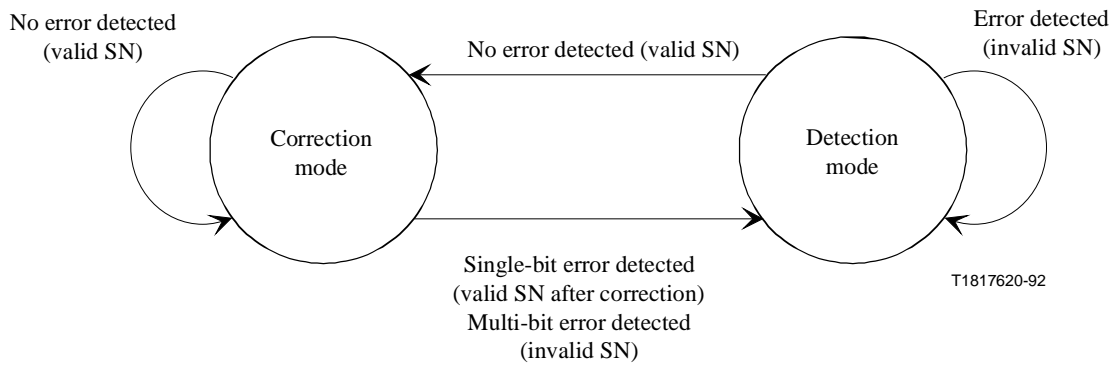

SN Sequence number

**Figure 4/I.363.1 – SNP: receiver modes of operation**

The receiver examines each SAR-PDU header by checking the CRC bits and even parity bit. If a header error is detected, the action taken depends on the state of the receiver. In the "Correction Mode", only single-bit errors can be corrected and the receiver switches to "Detection Mode". In "Detection Mode", all SAR-PDU headers with detected errors are declared to have an invalid SN; however, when a SAR-PDU header is examined and found not to be in error, the receiver switches to "Correction Mode".

Tables 1 and 2 give the detailed operations of the receiver in the "Correction Mode" and "Detection Mode", respectively. The operation is based on the combined validity of the CRC and parity check bit.

The receiver conveys the sequence number count and the CS indication to the CS together with SN check status (valid or invalid).

**Table 1/I.363.1 – Operations in Correction Mode**

CRC syndrome	Parity	Action on current SN + SNP	Reaction for next SN + SNP
Zero	No violation	No corrective action. Declare SN valid.	Continue in Correction Mode
Non-zero	Violation	Single-bit correction based on syndrome. Declare SN valid.	Switch to Detection Mode
Zero	Violation	Correct parity bit. Declare SN valid.	Switch to Detection mode
Non-zero	No violation	No corrective action: multi-bit errors are uncorrectable. Declare SN invalid.	Switch to Detection mode

**Table 2/I.363.1 – Operations in Detection Mode**

<b>CRC syndrome</b>	<b>Parity</b>	<b>Action on current SN + SNP</b>	<b>Reaction for next SN + SNP</b>
Zero	No violation	No corrective action. Declare SN valid.	Switch to Correction Mode
Non-zero	Violation	No corrective action. Declare SN invalid.	Continue in Detection Mode
Zero	Violation	No corrective action. Declare SN invalid.	Continue in Detection mode
Non-zero	No violation	No corrective action. Declare SN invalid.	Continue in Detection mode

## **2.5 Convergence Sublayer (CS)**

### **2.5.1 Functions of the CS**

The CS may include the following functions:

- a) Blocking of user information to form a 47-octet block of SAR-PDU payload is performed at this sublayer. If no octet interleaving is applied, the AAL-SDUs are sequentially concatenated. They are placed left justified in the 47-octet block beginning from the first octet available for user information. The deblocking function is the reverse of the blocking function. It segments the user information into a stream of AAL-SDUs again.
- b) Handling of cell delay variation is performed at this sublayer for delivery of AAL-SDUs to an AAL user at a constant bit rate.
- c) Handling of SAR-PDU payload assembly delay may be performed by partially filling the SAR-PDU payload.
- d) Processing of sequence count may be performed at this sublayer. The sequence count value and its error check status provided by the SAR sublayer can be used by the CS to detect cell loss and misinsertion. Further handling of lots and misinserted cells is also performed in this sublayer.
- e) The CS can utilize the CS indication provided by the SAR sublayer to support CS functions for some AAL users. When the CS indication is not used, the CSI bit is set to "0" by the transmitter, and no further CS action related to that indication is performed at the receiver, i.e. the CS receiver ignores the received CSI value.
- f) For AAL users requiring recovery of source clock frequency at the destination end, the AAL can provide a mechanism for a timing information transfer.
- g) For some AAL users, this sublayer provides the transfer of structure information between source and destination.
- h) For video and high quality audio signal transport, forward error correction may be performed to protect against bit errors. This may be combined with interleaving of AAL user bits (i.e. octet interleaving) to correct cell losses.
- i) The CS may generate reports giving the status of end-to-end performance as deduced by the AAL. The performance measures in these reports could be based on:
  - events of lost and misinserted cells;
  - buffer underflow and overflow;
  - bit error events.

AAL type 1 protocol aims at having as many common procedures as possible among various types of CBR services in an ATM network. As such, AAL type 1 CS protocol is somewhat of a tool kit, whereby a specific higher layer needs to choose procedures given in this Recommendation, taking account of required service features (i.e. synchronous or asynchronous transport), required performance (i.e. error and delay characteristics at the AAL service boundary), and anticipated network performance (i.e. cell losses and delay variations).

The following subclauses describe CS functions needed for four layer services, i.e. circuit transport, video signal transport, voiceband signal transport and high quality audio signal transport. These subclauses also refer to a specific procedure which is defined in 2.5.2, where the description of each procedure is independent from CS functions. These four layer services and associated description of required procedures are general and not exhaustive. Appendix II gives informative and example parameters, i.e. a set of procedures and options, for some specific AAL type 1 services. Having this structural description, this Recommendation gives the ground for a generic protocol to support a large number of CBR services.

### **2.5.1.1 Functions of the CS for circuit transport**

The following functions support both asynchronous and synchronous circuit transport. Asynchronous circuit transport will provide transport of signals from constant bit rate sources whose clocks are not frequency-locked to a network clock. Examples are Recommendation G.702 signals at 1.544, 2.048, 6.312, 8.448, 32.064, 44.736 and 34.368 Mbit/s. Synchronous circuit transport will provide transport of signals from constant bit rate sources whose clocks are frequency-locked to a network clock. Examples are signals at 64, 384, 1536 and 1920 kbit/s as described in Recommendation I.231.

NOTE – Another possible example of synchronous circuit transport is conveyance of SDH signals described in Recommendation G.709.

#### *a) Handling of AAL user information*

The length of the AAL-SDU is one bit, when asynchronous circuit transport utilizes the Synchronous Residual Time Stamp (SRTS) method described in 2.5.2.2.2.

For those AAL users who require transfer of structured data, i.e. 8 kHz structured data for circuit mode bearer services of the 64 kbit/s-based ISDN, the STRUCTURE parameter option of the primitives defined in 2.1.2 will be used. The CS uses the Structured Data Transfer (SDT) method described in 2.5.2.3.

#### *b) Handling of cell delay variation*

A buffer is used to support this function. The size of this buffer is dependent upon specifications provided in Recommendation I.356.

In the event of buffer underflow, it may be necessary for the CS to maintain bit count integrity by inserting the appropriate number of dummy bits. In the event of buffer overflow, it may be necessary for the CS to maintain bit count integrity by dropping the appropriate number of bits.

When Recommendation G.702 1.544-Mbit/s and 2.048-Mbit/s signals are being transported, the inserted dummy bits shall be all "1"s.

#### *c) Handling of lost and misinserted cells*

The sequence count values are further processed at this sublayer to detect lost and misinserted cells. Detected misinserted cells are discarded. The CS procedure to be used for sequence count processing is described in 2.5.2.1.

In order to maintain the bit count integrity of the AAL user information, it may be necessary to compensate for lost cells detected by buffer underflow and sequence count processing by inserting the appropriate number of dummy SAR-PDU payloads. The content of this dummy

SAR-PDU payload depends on the AAL service being provided. For example, this dummy SAR-PDU payload is all "1"s for Recommendation G.702 1.544 Mbit/s and 2.048-Mbit/s signals.

d) *Handling of timing relation*

This function is required for delivery of AAL-SDUs to an AAL user at a constant bit rate. Recovered source clock should have satisfactory jitter and wander performance. For example, the jitter and wander performance for Recommendation G.702 signals is specified in Recommendations G.823 and G.824, for which the CS procedure to be used (the SRTS method) is described in 2.5.2.2.2.

### 2.5.1.2 Functions of the CS for video signal transport

The following functions support transport of video signals for interactive and distributive services:

a) *Handling of AAL user information*

The length of the AAL-SDU is one octet, when utilizing the correction methods described in 2.5.2.4.

For those AAL users who require transfer of structured data, the STRUCTURE parameter option of primitives defined in 2.1.2 will be used. The CS uses the SDT method described in 2.5.2.3.

Depending on the type of AAL service provided (i.e. the interface to the AAL user), the STATUS parameter defined in 2.1.2 will be passed to the AAL user to facilitate further picture processing, i.e. error concealment or not.

b) *Handling of cell delay variation*

A buffer is used to support this function. The size of this buffer is dependent upon specifications provided in Recommendation I.356.

In the event of buffer underflow, it may be necessary for the CS to maintain bit count integrity by inserting the appropriate number of dummy bits. In the event of buffer overflow, it may be necessary for the CS to maintain bit count integrity by dropping the appropriate number of bits.

c) *Handling of lost and misinserted cells*

The sequence count values are further processed at this sublayer to detect lost and misinserted cells. Detected misinserted cells are discarded. The CS procedure to be used for sequence count processing is described in 2.5.2.1.

In order to maintain the bit count integrity of the AAL user information, it may be necessary to compensate for lost cells detected by buffer underflow and sequence count processing by inserting the appropriate number of dummy SAR-PDU payloads. The content of this dummy SAR-PDU payload depends on the AAL service being provided.

Information in lost cells may be recovered by the mechanism described in e).

d) *Handling of timing relation*

This function is required for delivery of AAL-SDUs to an AAL user at a constant bit rate.

Some AAL users may require source clock frequency recovery, i.e. recovery at the receiving end of camera clock frequency which is not locked to the network clock. The CS procedures available for that purpose are given in 2.5.2.2.

e) *Correction of bit errors and lost cells*

This is an optional function provided for those AAL users requiring error correction, i.e. bit error and/or cell loss performance better than that provided by the ATM and physical layer.



Examples are unidirectional video services for contribution and distribution. This function may be performed with the CS procedure described in 2.5.2.4.

### 2.5.1.3 Functions of the CS for voiceband signal transport

The following functions support transport of a single voiceband signal, i.e. one 64 kbit/s A-law or  $\mu$ -law coded Recommendation G.711 signal.

a) *Handling of AAL user information*

The length of the AAL-SDU is one octet. Forty-seven consecutive AAL-SDUs constitute one SAR-PDU payload, i.e. partially filled cells are not used. The CS provides structured data transfer with single octet delineation, i.e. the pointer is not used.

b) *Handling of cell delay variation*

A buffer is used to support this function. The size of this buffer depends on specifications provided in Recommendation I.356.

c) *Handling of lost and misinserted cells*

For voiceband signals, there is no need to detect misinserted cells.

The receiving AAL entity must detect/compensate for lost cell events to maintain bit count integrity and must also minimize the delay, i.e. to alleviate echo performance problems, in conveying the individual voiceband signal octets from the SAR-PDU payload to the AAL user. The receiving AAL entity may take actions based on the received SN values, but such actions must not increase the conveyance delay across the AAL receiving entity beyond the nominal CDV value to alleviate echo performance problems.

The AAL receiving entity must accommodate a sudden increase or decrease in the nominal cell transfer delay. (Such a change in cell transfer delay can be the result of a protection switching event in the network.)

d) *Handling of timing relation*

The CS provides synchronous circuit transport for the voiceband signal.

NOTE 1 – Example receiver techniques using a timing-based mechanism or a buffer-fill-based mechanism, possibly supplemented by an SN processing algorithm that does not introduce additional delay, are given in Appendix III.

NOTE 2 – For transporting signals of speech and 3.1 kHz audio bearer services as specified in 64 kbit/s ISDN, the need for A/ $\mu$ -law conversion is identified. The conversion between A-law and  $\mu$ -law coded PCM octets is as specified in Recommendation G.711. This conversion function is outside the scope of this Recommendation.

### 2.5.1.4 Functions of the CS for high quality audio signal transport

The capabilities of AAL type 1 are in principle applicable for transfer of high quality audio signals.

- a) Handling of AAL user information;
- b) Handling of cell delay variation;
- c) Handling of lost and misinserted cells;
- d) Handling of timing relation;
- e) Correction of bit errors and lost cells.

## 2.5.2 Convergence Sublayer (CS) protocol

The following subclauses describe CS procedures to be provided for implementing CS functions. The use of each procedure depends on the required CS functions and is given in 2.5.1.

## **2.5.2.1 Sequence count operations**

### **2.5.2.1.1 Sequence count operations at the transmitting end**

At the transmitting end, the CS provides the SAR with a sequence count value and a CS indication associated with each SAR-PDU payload. The count value starts with 0, is incremented sequentially and is numbered modulo 8.

### **2.5.2.1.2 Sequence count operations at the receiving end**

At the receiving end, the CS receives from the SAR the following information associated with each SAR-PDU payload:

- sequence count;
- CS indication;
- check status of the sequence count and CS indication.

The use of sequence count values and CS indications will be specified on a service specific basis. See 2.4.2 for details about the check status processing.

The CS processing at the receiving end may identify lost or misinserted SAR-PDU payloads. This will be useful for many CBR services.

CS processing may identify the following conditions:

- SAR-PDU payload sequence normal (i.e. in correct sequence);
- SAR-PDU payload loss;
- SAR-PDU payload misinsertion.

Processing of sequence count values may provide additional information to related entities within the CS, as required. Some examples are:

- location of lost SAR-PDU payload in the incoming SAR-PDU stream;
- number of consecutive SAR-PDU payloads lost;
- identification of misinserted SAR-PDU payload.

Informative examples of algorithms for the processing of sequence count values are given in Appendix III. Independent of which type of algorithm is used, additional mechanisms have to be realized to preserve bit count integrity. This can, for example, be achieved by defining a time window (whose width is related to the nominal CDV) around the expected arrival instant of the next cell or by interpreting the buffer-fill level and inserting or discarding the appropriate number of bits.

NOTE – Processing of sequence count values may be subject to performance specifications. The performance specifications will be applied on a service specific basis.

### **2.5.2.2 Source clock frequency recovery method**

For synchronous CBR services, the clock is locked to a clock available from the network.

The CS provides two methods for the support of asynchronous CBR services with clocks not locked to a network clock.

- Adaptive clock method for those services which need to comply with jitter requirements but which do not need to comply with wander requirements, i.e. Recommendation G.823/G.824;
- Synchronous Residual Time Stamp (SRTS) method for those services which need to comply with jitter and wander requirements, i.e. Recommendation G.823/G.824.

If a circuit transport equipment is connected to the public network, the requirements of jitter and wander depend on services. For services which need to meet the jitter and wander specifications in Recommendation G.823/G.824, the use of SRTS method is recommended. In private networks with no stringent wander requirement, the adaptive clock method may be used.

#### 2.5.2.2.1 Adaptive clock method

The adaptive clock method is a general method for source clock frequency recovery. No explicit timing information of the source clock is transported by the network; the method is based on the fact that the amount of transmitted data is an indication of the source frequency, and this information can be used at the receiver to recover the source clock frequency. By averaging the amount of received data over a period of time, CDV (Cell Delay Variation) effects are counteracted. The period of time used for averaging depends on the CDV characteristics.

The adaptive clock method is implemented at the receiving AAL. The implementation of the method is not standardized. One possible method to measure the amount of data is to use the fill level of the AAL user data buffer. The following is the general description of this method and does not preclude other adaptive clock methods.

The receiver writes the received data into a buffer and then reads it out using a locally generated clock. Therefore, the fill level of the buffer depends on the source frequency and it is used to control the frequency of the local clock. Operations are the following: the fill level of the buffer is continuously measured and the measure is used to drive the phase-locked loop generating the local clock. The method maintains the fill level of the buffer around its medium position. To avoid buffer underflow or overflow, the fill level is maintained between two limits. When the level in the buffer goes to the lower limit, this means the frequency of the local clock is too high compared to the one of the source and so it has to be decreased; when the level in the buffer goes to the upper limit, the frequency of the local clock is too low compared to the one of the source and so it has to be increased.

#### 2.5.2.2.2 Synchronous Residual Time Stamp (SRTS) method

##### a) *General*

The Synchronous Residual Time Stamp (SRTS) method uses the Residual Time Stamp (RTS) to measure and convey information about the frequency difference between a common reference clock derived from the network and a service clock. The same derived network clock is assumed to be available at both the transmitter and the receiver. If the common network reference clock is unavailable (i.e. when working between different networks which are not synchronized), then the asynchronous clock recovery method will be in a mode of operation associated with "Plesiochronous network operation" which is described in item e). The SRTS method is capable of meeting the jitter specifications of the 2.048 Mbit/s hierarchy in Recommendation G.823 and the 1.544 Mbit/s hierarchy in Recommendation G.824.

The following is a description of the SRTS method. The description uses the notation below:

$f_s$	– service clock frequency;
$f_n$	– network clock frequency, i.e. 155.52 MHz;
$f_{nx}$	– derived reference clock frequency, $f_{nx} = f_n/x$ where $x$ is a rational number to be defined later;
$N$	– period of RTS in cycles of the service clock of frequency $f_s$ ;
$T$	– period of the RTS in seconds;

$M(M_{\text{nom}}, M_{\text{max}}, M_{\text{min}})$  – number of  $f_{\text{rx}}$  cycles within a (nominal, maximum, minimum) RTS period;

$M_q$  – largest integer smaller than or equal to  $M$ .

The SRTS concept is illustrated in Figure 5. In a fixed duration  $T$  measured by  $N$  service clock cycles, the number of derived network clock cycles  $M_q$  is obtained at the transmitter. If  $M_q$  is transmitted to the receiver, the service clock of the source can be reconstructed by the receiver, since it has the necessary information:  $f_{\text{rx}}$ ,  $M_q$  and  $N$ . However,  $M_q$  is actually made up of a nominal part and a residual part. The nominal part  $M_{\text{nom}}$  corresponds to the nominal number of  $f_{\text{rx}}$  cycles in  $T$  seconds and is fixed for the service. The residual part conveys the frequency difference information as well as the effect of the quantization and thus can vary. Since the nominal part is a constant, it can be assumed that the nominal part of  $M_q$  is available at the receiver. Only the residual part of  $M_q$  is transmitted to the receiver.

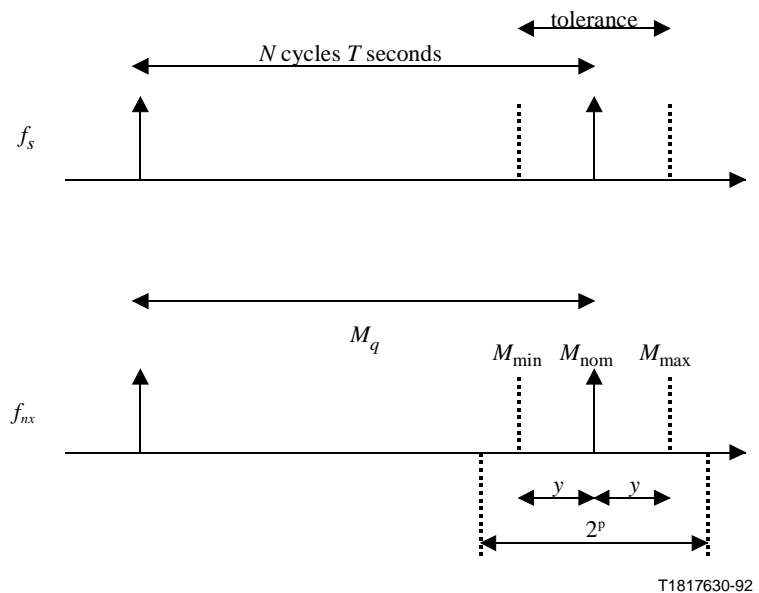

**Figure 5/I.363.1 – The concept of Synchronous Residual Time Stamp (SRTS)**

A simple way of representing the residual part of  $M_q$  is by means of the RTS, whose generation is shown in Figure 6. Counter  $C_t$  is a  $P$ -bit counter which is continuously clocked by the derived network clock. The output of counter  $C_t$  is sampled every  $N$  service clock cycle. This  $P$ -bit sample is the Residual Time Stamp.

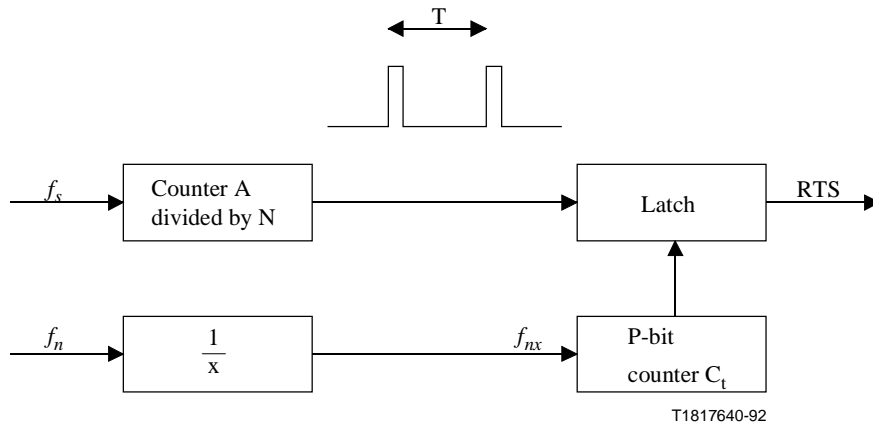

**Figure 6/I.363.1 – Generation of Residual Time Stamp (RTS)**

With a knowledge of the RTS and the nominal part of  $M_q$  at the receiver,  $M_q$  is completely specified.  $M_q$  is used to produce a reference timing signal for a Phase-Locked Loop to obtain the service clock.

b) *Choice of parameter*

The minimum size of the RTS required to unambiguously represent the residual part of  $M_q$  is a function of  $N$ , the ratio  $f_{nx}/f_s$ , and the service clock tolerance,  $\pm \epsilon$ . Let  $y$  be the difference between  $M_{nom}$  and the maximum or minimum value of  $M$  (denoted as  $M_{max}$ ,  $M_{min}$ ). The difference  $y$  is given by:

$$y = N \times \frac{f_{nx}}{f_s} \times \epsilon$$

In order that  $M_q$  can be unambiguously identified, the following conditions must be satisfied (see Figure 5);

$$2^{(p-1)} > \lceil y \rceil$$

where  $\lceil y \rceil$  denotes the smallest integer larger than or equal to  $y$ .

The following parameter values are used for the asynchronous circuit transport of Recommendation G.702 signals:

$N = 3008$  (total number of bits in eight SAR-PDU payloads);

$1 \leq f_{nx}/f_s < 2$ ;

Tolerance =  $200 \times 10^{-6}$ ;

Size of RTS = 4 bits.

The introduction of any AAL convergence sublayer overhead into the SAR-PDU payload will reduce the amount of payload available for the transport of AAL user data. This will reduce the number of service clock cycles over which the RTS period is specified, since the RTS period is defined over a fixed number of SAR-PDU payloads. The RTS period parameter,  $N$ , can be adjusted to accommodate such cases.

The CS overhead has to be allocated so that the RTS period always remains a constant number of service clock cycles. Therefore, the CS overhead must reduce the user data transport capacity by a constant amount over the fixed number of SAR-PDU payloads for

which the RTS period is defined. As an example, the P format in the SDT method is used exactly once per cycle, where a cycle is the sequence of eight consecutive SAR-PDUs with the sequence count values 0 through 7,  $N$  is reduced from 3008 to 3000.

c) *Derived reference clocks*

For SDH and non-SDH physical layers, a clock at frequency  $f_8 = 8$  kHz, synchronized to a common network clock, is available from which clocks at frequencies

$$f_{nx} = f_8 \times \frac{19\,440}{2^k} \text{ kHz}, \quad k = 0, 1, 2 \dots 11$$

can be derived. This set of derived frequencies can accommodate all service rates from 64 kbit/s up to the full capacity of the STM-1 payload. The exact value of  $f_{nx}$  to be used is uniquely specified since the frequency ratio is constrained by  $1 \leq f_{nx}/f_s < 2$ .

As an example, to support a service rate of 1544 kbit/s or 2048 kbit/s, the derived network frequency will be  $f_{nx} = f_8 \times 19\,440/2^6 = 2430$  kHz. As a further example, the derived network frequency for a service rate of 34 368 kbit/s and 44 736 kbit/s will be 38 880 kHz and 77 760 kHz respectively.

NOTE – This standard does not imply that an actual implementation explicitly derives a clock at frequency  $f_8$  and then, in turn, derives another clock at frequency  $f_{nx}$  by performing the multiplication by 19 440 and division by  $2^k$  entailed in the stated formula for  $f_{nx}$ .

Administrations/ROAs may use existing network clocks to support national service in a non-SDH ATM network.

d) *Transport of the RTS*

The 4-bit RTS is transmitted in the serial bit stream provided by the CSI bit in successive SAR-PDU headers. The modulo 8 sequence count provides a frame structure over 8 bits in this serial bit stream. Four bits of the framed 8 bits are allocated for the RTS and the remaining 4 bits are available for other uses. The SAR-PDU headers with the odd sequence count values of 1, 3 5 and 7 are used for RTS transport. The MSB of the RTS is placed in the CSI bit of the SAR-PDU header with the sequence count of 1.

e) *Plesiochronous network operation*

The issue about the accommodation of plesiochronous operation (i.e. when a common reference clock is not available from the network) needs to be addressed. This scenario must be accommodated in such a way that the recovered clock satisfies the requirements specified in Recommendations G.823 and G.824 for Recommendation G.702 signals. However, the detailed method of dealing with plesiochronous operation is not standardized.

### 2.5.2.3 Structured Data Transfer (SDT) method

The CS procedure for structured data transfer supports any fixed octet-based structure. In particular, it supports 8 kHz-based structures used in circuit-mode services of Recommendation I.231. When the structure size is greater than one octet, the CS procedure uses a pointer to delineate the structure boundaries.

The STRUCTURE parameter in the AAL-UNITDATA request and AAL-UNITDATA indication primitives is used to convey structure information between the AAL and the AAL user. See 2.1.2 for definition of primitives and parameters.

The 47-octet SAR-PDU payload used by the CS has two formats, called non-P and P format as shown in Figure 7.

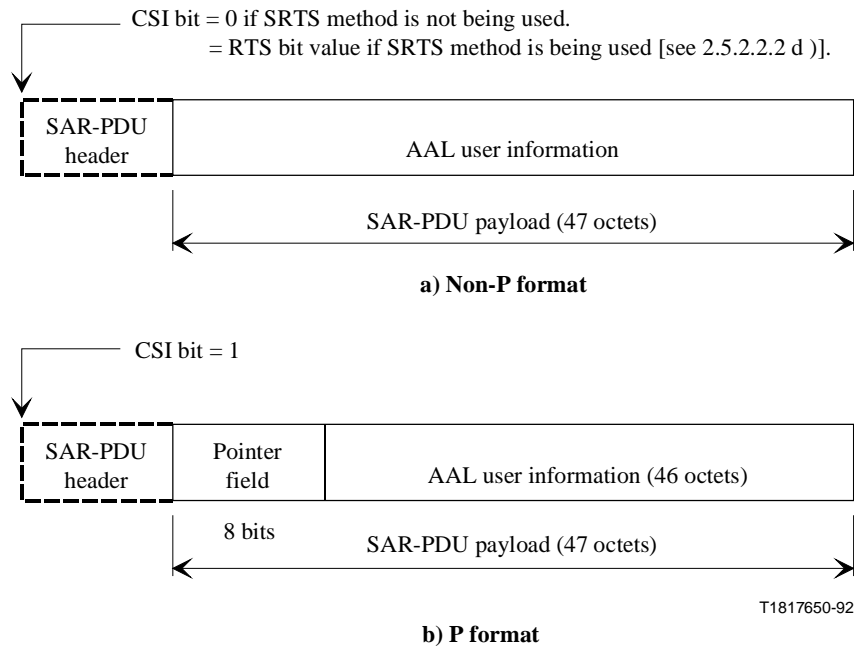

**Figure 7/I.363.1 – Format of SAR-PDU payload for structured data transfer method**

With SDT, the blocking of AAL user information into SAR-PDU payloads at the sending AAL-CS and the deblocking of AAL user information from a SAR-PDU payload at the receiving AAL-CS is required to:

- maintain the integrity of each AAL user octet transferred between the AAL-CS and the AAL user by aligning each AAL user octet with a payload octet position;
- maintain the sequential order of the AAL user octets with the first AAL user octet in a payload assigned to the payload octet position adjacent to the SAR-PDU header (i.e. non-P format payload) or SDT header (i.e. P format payload).

When the block size value is "1", the SDT protocol generates only non-P format SAR-PDU payloads, since the preservation of octet integrity provides the necessary structure boundary information. For block sizes greater than "1", the SDT protocol requires the generation of a pointer (i.e. P format payload) to provide SDT block boundary information once in each eight SAR-PDUs payloads associated with a sequence count cycle.

a) *Operations of the non-P format*

In the non-P format, the entire CS-PDU is filled with user information. This format is always used if the sequence count value in the SAR-PDU header is 1, 3, 5 or 7.

b) *Operations of the P format*

The CS procedure only uses the P format when the block size is greater than one octet.

In the P format, the first octet of the SAR-PDU payload is the pointer field. The remainder is filled with user information. This format may be used only if the sequence count value in the SAR-PDU header is 0, 2, 4 or 6.

The format of the pointer field is shown in Figure 8.

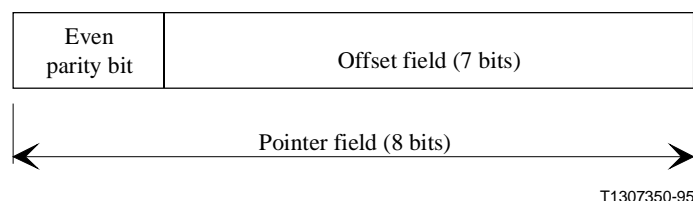

**Figure 8/I.363.1 – Pointer field format**

The pointer field contains the binary value of the offset, measured in octets, between the end of the pointer field and the first start of the structured block in the 93-octet payload consisting of the remaining 46 octets of this SAR-PDU payload and the 47 octets of the next SAR-PDU payload. This offset ranges between 0 and 93 inclusive. The offset value 93 is used to indicate that the end of the 93-octet payload coincides with the end of a structured block. Moreover, the dummy offset value 127 is used when no structure boundary is being indicated.

The binary value of the offset is inserted right justified in the offset field, i.e. the least significant bit of the offset is transmitted last. The first bit of the pointer field is used to provide an even parity over the pointer field.

The P format is used exactly once in every cycle, where a cycle is the sequence of eight consecutive SAR-PDUs with sequence count values 0 through 7. The P format is used at the first available opportunity in a cycle to point to a start of a structure boundary. If neither a start of a structure boundary nor an end of a structure boundary is present in a cycle, then the P format with the dummy offset value in the pointer field is used at the last opportunity in the cycle, i.e. SAR-PDU with sequence count value 6.

If a start of a structure boundary is not present in a cycle but coincides with the beginning of the next cycle, then the P format with offset value 93 in the pointer field is used in the SAR-PDU with sequence count value 6 and the P format with offset value 0 in the pointer field is used in the SAR-PDU with sequence count value 0 in the next cycle.

In keeping with the above pointer rule, the first structured block to be transmitted after the AAL connection is established uses the P format with sequence count value in the SAR-PDU header equal to 0 and with the first octet of the structured data placed in the second octet of the SAR-PDU payload.

#### **2.5.2.4 Correction methods for bit errors and/or cell losses**

Three correction methods are described:

- Correction method for bit errors;
- Correction method for bit errors and cell losses without delay restrictions;
- Correction method for bit errors and cell losses with delay restrictions.

##### **2.5.2.4.1 Correction method for bit errors**

This correction method makes use of Forward Error Correction (FEC) using the Reed-Solomon (128, 124) codes which are able to correct up to 2 errored octets. Reed-Solomon codes to be used are built over Galois Field (256) and the generator polynomial is given by:

$$\prod_{i=0}^3 (\chi - \alpha^{i+k})$$



where  $\alpha$  is a root of the binary primitive polynomial  $x^8 + x^7 + x^2 + x + 1$ , and  $k$  is the base exponent of the generator polynomial with  $k = 120$ .

In the transmitting CS, the 4-octet Reed-Solomon code is appended to 124 octets of incoming data from the upper layer. See Figure 9 for the structure and format of the FEC block.

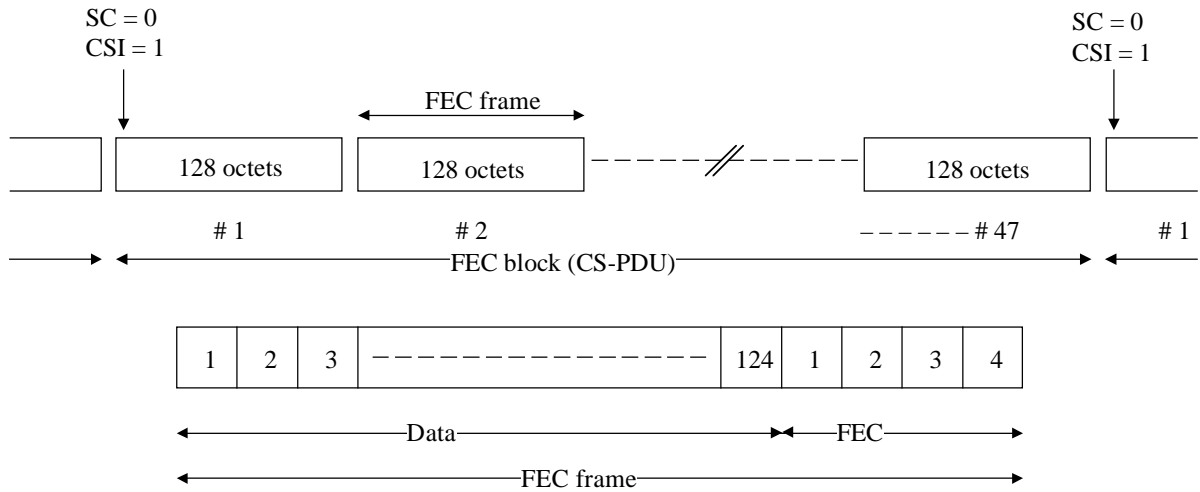

**Figure 9/I.363.1 – Structure and format of a FEC block**

A FEC block is organized as a group of 47 consecutive FEC frames. Each FEC frame contains 128 octets, i.e. the FEC block has  $128 \times 47 = 6016$  octets. Such a FEC block constitutes one CS-PDU.

For the synchronization of the CS-PDU, the CS indicator bit of the SAR-PDU header is set to 1 for the first SAR-PDU payload and is set to 0 for the remaining SAR-PDUs of the CS-PDU. This use of the CS indication bit precludes the use of the SDT method as specified in 2.5.2.3.

This method can mainly perform the following correction:

- 2 errored octets in each FEC frame if there is no cell loss.

This method is applicable when only cell loss detection is needed and there is no cell correction. Cell loss detection implies the insertion of 47 consecutive dummy octets. Misinserted cells which have been detected are merely discarded in the CS.

The overhead of this method is 3.1% and the delay is approximately 3 cells at the receiver.

#### 2.5.2.4.2 Correction method for bit errors and cell losses without delay restrictions

This correction method combines Forward Error Correction (FEC) and octet interleaving, from which a CS-PDU structure is defined. FEC uses the Reed-Solomon (128, 124) code which is able to correct up to 2 errored symbols (octets) or 4 erasures in the block of 128 octets. An erasure is an errored octet whose location in the block is known. Reed-Solomon codes to be used are built over Galois Field (256) and the generator polynomial is given by:

$$\prod_{i=0}^3 (\chi - \alpha^{i+k})$$

where  $\alpha$  is a root of the binary primitive polynomial  $x^8 + x^7 + x^2 + x + 1$ , and  $k$  is the base exponent of the generator polynomial with  $k = 120$ .

In the transmitting CS, the 4-octet Reed-Solomon code is appended to 124 octets of incoming data from the upper layer. The resulting 128-octet-long blocks are then forwarded to the octet interleaver. See Figure 10 for the format of the interleave matrix.

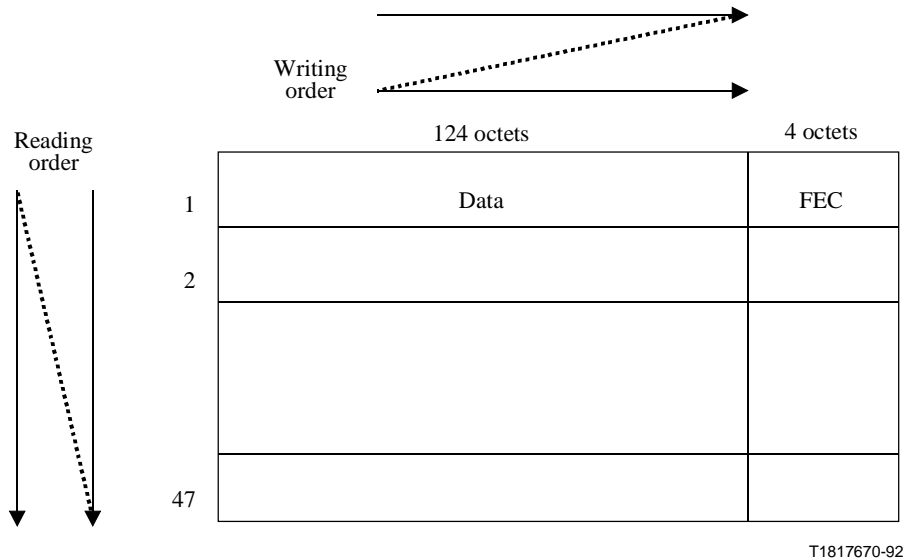

**Figure 10/I.363.1 – Structure and format of the long interleaver matrix**

The octet interleaver is organized as a matrix of 128 columns and 47 rows. The interleaver is used as follows: at the input, incoming 128-octet-long blocks are stored row by row (one block corresponding to one row); at the output, octets are read out column by column. The matrix has  $128 \times 47 = 6016$  octets, corresponding to 128 SAR-PDU payloads. These 128 SAR-PDU payloads constitute one CS-PDU.

In this process, the loss of one SAR-PDU payload in the matrix implies one erasure to correct in each row of the matrix. Erasures correspond to dummy cell payloads inserted in the cell flow when a cell loss has been detected. Misinserted cells which have been detected are merely discarded in the CS.

For the synchronization of the CS-PDU, the CS indicator bit of the SAR-PDU header is set to 1 for the first SAR-PDU payload of the CS-PDU. This use of the CS indication bit precludes the use of the SDT method as specified in 2.5.2.3.

Within any CS-PDU matrix, this method can perform the following corrections:

- 4 cell losses; or
- 2 cell losses and 1 errored octet in each row; or
- 2 errored octets in each row if there is no cell loss.

The overhead of this method is 3.1% and the delay is 128 cells both at the sending side and the receiving side.

#### 2.5.2.4.3 Correction method for bit errors and cell losses with delay restrictions

##### a) *Characteristics of the method*

The method combines FEC using Reed-Solomon codes and octet interleaving of data. The size of the interleaver is 16 cells, the interleaving matrix has 8 rows and 94 columns. The method utilizes Reed-Solomon (94, 88) codes. The erasure mode is used for the correction of

dummy octets corresponding to cell loss locations. Reed-Solomon codes to be used are built over Galois Field (256) and the generator polynomial is given by:

$$\prod_{i=0}^5 (\chi - \alpha^{i+k})$$

where  $\alpha$  is a root of the binary primitive polynomial  $x^8 + x^7 + x^2 + x + 1$ , and  $k$  is the base exponent of the generator polynomial with  $k = 120$ .

A diagonal interleaving mechanism is used to decrease the processing delay of the method. In the interleaver, the writing mode and the reading mode are alternate. The process in the interleaver is continuous, i.e. only one interleaver is necessary at each end. See Figure 11 for structure of the short interleaver matrix.

	88 octets	6 octets
1	Data	FEC
2		
8		

**Figure 11/I.363.1 – Structure of the short interleaver matrix**

b) *Operation at the transmitting end*

RS codes for a row are calculated prior to writing in the interleaver. The writing order in the interleaver is horizontal. The reading order is diagonal. The process is operated octet by octet. Let  $a(i, j)$  be a coefficient (i.e. an octet) in the matrix, where  $i$  is the row number and  $j$  the column number. Then the sequence of coefficients to be read out of the matrix diagonally is as follows:

$$\dots, a(i+1, j-1), a(i, j), a(i-j, j+1), \dots$$

The format and organization of the interleaver is given in Figure 12.

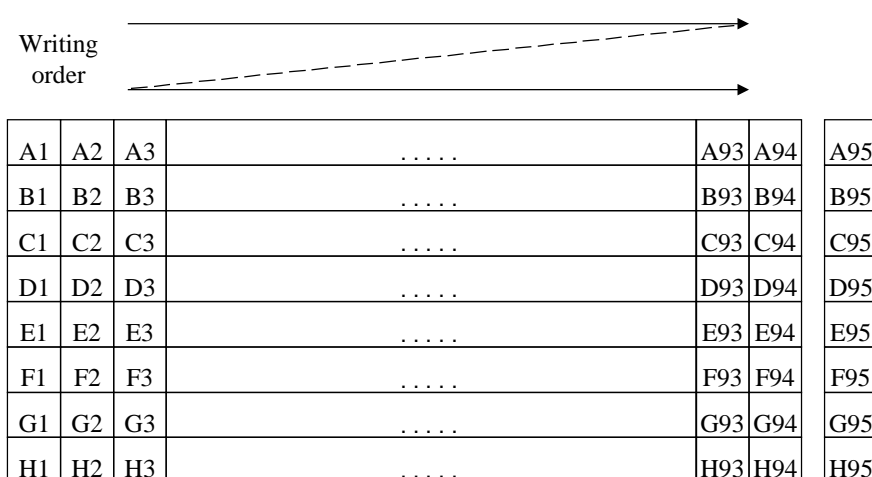

T1306750-95

**Figure 12/I.363.1 – Format and organization of the short interleaver matrix**

For a correct reading order of the diagonal mechanism, a virtual column is added (Number 95). It is used only for counting; it does not contain any information and it is not transmitted. It is mentioned in "parentheses" in the following sequences only to permit a good understanding of the reading order. Examples of 47 octets sequences that are read out of the interleaver are given hereafter:

...  
 seq. k : (B95),A1,H2,G3,...,A9,H10,...,A17,...,A25,...,A33,...,A41,...,C47.  
 seq. k+1 : B48,A49,H50,...,B56,...,B64,...,B72,...,B80,...,B88,...,D94.  
 seq. k+2 : (C95),B1,A2,H3,G4,...,B9,...,B17,...,B25,...,B33,...,B41,...,D47.  
 seq. k+3 : C48,B49,A50,...,C56,...,C64,...,C72,...,C80,...,C88,...,E94.  
 seq. k+4 : (D95),C1,B2,...,C9,...,C17,...,C25,...,C33,...,C41,...,E47.  
 ...

1) *Operation at the beginning of the communication*

At the beginning of the communication, the reading of the interleaver begins, before it is completely filled up. The reading process begins as soon as the first octet has been written in the interleaver. As a result, in the first SAR-PDUs of the communication, only some octets carry valid information. Other octets contain dummy information as they correspond to positions in the interleaver which have not yet been filled. The communication begins as follows (x: dummy octets):

1st SAR-PDU : A1,x..x,A9,x..x,A17,x..x,A25,x..x,A33,x..x,A41,x..x.  
 2nd SAR-PDU : x,A49,x..x,A57,x..x,A65,x..x,A73,x..x,A81,x..x,A89,x..x.  
 3rd SAR-PDU : B1,A2,x..x,B9,A10,x..x,B17,A18,x..x,B25,A26,x..x,B33,A34,  
 x..x,B41,A42,x..x.

The first SAR-PDU to be completed with valid octets is number 15.

2) *Operation at the end of the communication*

At the end of the communication, the transmitting interleaver is read out until it gets completely empty. Some data of the transmitting interleaver will be transmitted twice, which has no action in the receiving interleaver where they will be stored a second time in positions that have already been read out, and which will be interpreted as dummy positions.

c) *Operation in the receiving end*

The mechanism in the receiving interleaver is the inverse of that of the transmitting interleaver, i.e. the writing order is diagonal and the reading order is horizontal. For the reading, the rule is the following: when the interleaver has been filled up with 14 SAR-PDUs, then the reading process is started for the first row.

d) *Delineation of the interleaver*

As the process is continuous in the interleaver, there is no real start of the interleaver. Only the even or odd value of the sequence number is necessary in the receiving CS to know if the corresponding SAR-PDU begins respectively with a coefficient numbered 1 or with a coefficient numbered 48.

e) *Performance*

Correction capabilities of this method are:

- one cell loss occurrence in the group of 16 cells;
- three errored octets in a row of 94 octets.

The overhead of the method is 6.38%.

The processing delay imposed by this method is as follows.

The following calculation of the processing delay takes into account both the transmitting and the receiving ends. Let  $D$  be the processing delay corresponding to a horizontal/vertical processed interleaver. Due to the diagonal mechanism, for a given row of the interleaver, the distribution of the delay is as follows:

- For the first octet of the interleaver, the delay is approximately null in the transmitter and approximately  $D$  in the receiver.
- For the last octet of the interleaver, the delay is approximately  $D$  in the transmitter and approximately null in the receiver.

As a result, for a given octet, the total delay is  $D$ . Examples of values are given for the total processing delay. Processing delays are: 14.7 ms for 384 kbit/s, 3.67 ms for 1536 kbit/s, 2.93 ms for 1920 kbit/s.

#### **2.5.2.5 Partially filled cell method for control of SAR-PDU payload assembly delay**

This method defines a CS procedure for partially filling the payload of a SAR-PDU to reduce payload assembly delay. The method may be of use with delay-sensitive CBR services. The procedure assumes that AAL-user information occupies the leading octets of the payload except for octets used for CS overhead (i.e. SDT pointer). The procedure assumes that other active AAL-CS functions generating overhead are defined so the receiving AAL-CS knows when the payload contains overhead, the number of overhead octets and the position of these octets in the payload. The partial fill procedure determines the number and position of AAL-user information octets and CS-generated dummy value octets in the remaining payload octets.

The number of AAL-user information octets in a SAR-PDU payload,  $N$  ( $N < 47$ ), must be determined from the maximum SAR-PDU payload assembly delay. Given a value for  $N$ , the procedure for assembling the SAR-PDU payload is:

- If no AAL type 1 CS protocol procedures introduce an overhead into the SAR-PDU payload, then the number of AAL-user octets is  $N$  and the leading octets in the SAR-PDU payload are used for the AAL-user information as shown in Figure 13 a).
- If AAL type 1 CS protocol procedures introduce an overhead of  $C$  octets ( $C \leq 47$ ) into the SAR-PDU payload (i.e. SDT), then the specified SAR-PDU payload octets are reserved for the CS overhead. The leading octets of the SAR-PDU payload, except for octets reserved for CS overhead, are again used for AAL-user information as shown in Figure 13 b).

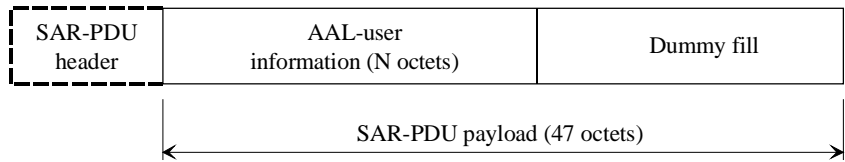

a) Partial fill with no AAL-CS overhead

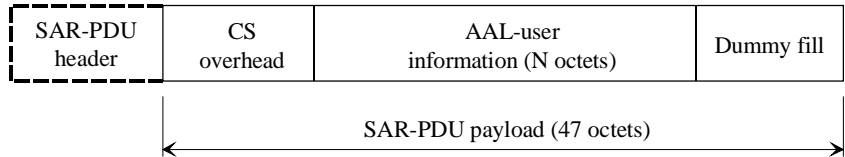

b) Example of partial fill with AAL-CS overhead

T1306760-95

**Figure 13/I.363.1 – Format of partially filled SAR-PDU payload**

Due to the introduction of CS overhead, two possible conditions exist with regard to SAR-PDU payload AAL-user information capacity:

- 1) If  $N + C \leq 47$ , N octets can be used for AAL-user information.
- 2) If  $N + C > 47$ , less than N octets can be used for AAL-user information.

When the CS overhead and number of AAL-user information octets in a SAR-PDU payload never exceeds 47 [i.e. condition 1) always applies], the number of AAL-user information octets in SAR-PDU payloads is always N and the payload assembly delay is a constant for all SAR-PDUs generated. Current CS procedures which may be combined with partial fill, such as SDT, only result in SAR-PDU payloads satisfying condition 1). When SAR-PDU payloads satisfying condition 2) may exist due to the introduction of CS procedures where  $N + C > 47$ , further study would be required.

If the number of SAR-PDU payload octets reserved for CS overhead and AAL-user information is less than 47, then the remaining payload octets assume a dummy value generated by the AAL-CS (see Note). At the receiving AAL entity, the CS shall not pass the payload octets with dummy values to the AAL-user.

NOTE – The value of the SAR-PDU dummy octets generated by the AAL-CS for the control of payload assembly delay is to be specified.

## ANNEX A

### Alphabetical list of abbreviations

AAL	ATM Adaptation Layer
AAL-PCI	AAL Protocol Control Information
AAL-PDU	AAL Protocol Data Unit
AAL-SDU	AAL Service Data Unit
ATM-SDU	ATM Service Data Unit
AUU	ATM-User-to-ATM-User

CAM	Cell Arrival Monitoring
CBR	Constant Bit Rate
CDV	Cell Delay Variation
CLP	Cell Loss Priority
CRC	Cyclic Redundancy Check
CS	Convergence Sublayer
CS-PDU	CS Protocol Data Unit
CSI	Convergence Sublayer Indication
FEC	Forward Error Correction
FIFO	First-In First-Out
MPEG	Moving Picture Experts Group
OAM	Operation and Maintenance
PDH	Plesiochronous Digital Hierarchy
RS	Reed-Solomon
RTS	Residual Time Stamp
SAP	Service Access Point
SAR	Segmentation and Reassembly sublayer
SAR-PDU	SAR Protocol Data Unit
SAR-SDU	SAR Service Data Unit
SDH	Synchronous Digital Hierarchy
SDT	Structure Data Transfer
SN	Sequence Number
SNP	Sequence Number Protection
SRTS	Synchronous Residual Time Stamp
VBR	Variable Bit Rate

## ANNEX B

### **Data unit naming convention**

The figure is to indicate the naming of the AAL data units only. It is not implied that all fields are present in all cases. See Annex A for abbreviations.

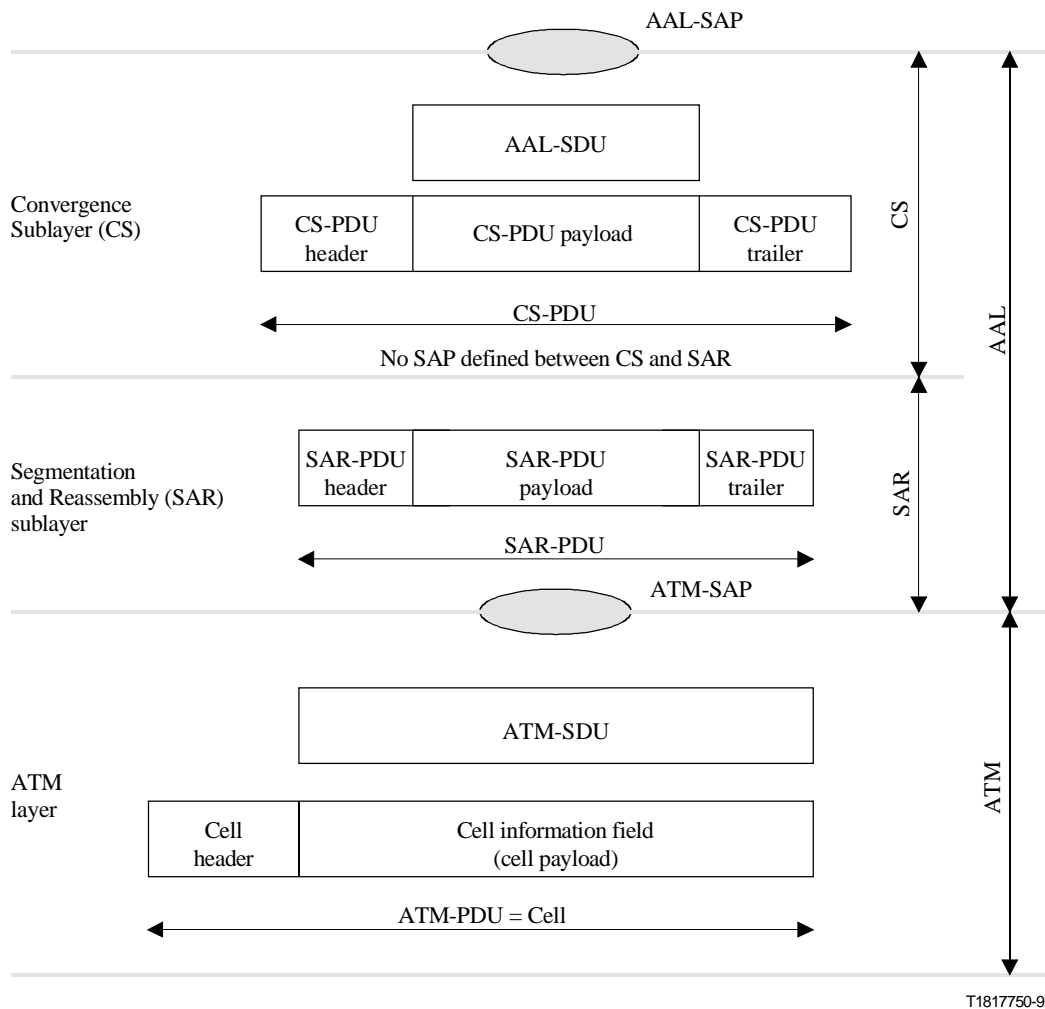

NOTE – ATM Adaptation Layer-Protocol Control Information (AAL-PCI) consists of the SAR-PDU header, CS-PDU header, CS-PDU trailer, and SAR-PDU trailer.

**Figure B.1/I.363.1 – Data unit naming convention**

## ANNEX C

### Encoding and information transfer principles

#### C.1 Cell payload field encoding

The encoding of the 384-bit/48-octet payload is defined relative to the cell header using the following conventions.

- 1) Bit positions in the 384-bit cell payload are located with respect to the cell header:
  - The first bit position in the cell payload is adjacent to the cell header and designated payload bit "1".
  - The last bit position in the cell payload is designated payload bit "384".
- 2) Octet positions in the 48-octet cell payload are located with respect to the cell header:
  - The first octet position in the cell payload is adjacent to the cell header (i.e. payload bit positions 1-8) and designated payload octet "1".



- The last octet position in the cell payload (i.e. payload bit positions 377-384) is designated payload octet "48".
- 3) Bits within a specified payload octet are oriented with respect to the cell header:
- The most significant bit (i.e.  $2^7$ ) position is the octet bit position nearest to the cell header which is designated octet bit "8".
  - The least significant bit position (i.e.  $2^0$ ) is the octet bit position furthest from the cell header which is designated octet bit "1".

Figure C.1 illustrates the encoding principles.

The orientation of bits/octetets within a cell payload field/subfield follows the convention for orienting bits in a payload octet when the cell payload field/subfield has multiple bits and the payload octet convention for orienting octets when the cell payload field/subfield has multiple octets:

- The most significant bit position of a cell payload field/subfield is the bit position nearest to the cell header and the least significant bit position of a cell payload field/subfield is the bit position furthest from the cell header when describing bit orientation.
- The first octet position of the field/subfield is the octet position nearest to the cell header and the last octet position of the field/subfield is the octet furthest from the cell header when describing octet orientation.

## C.2 AAL user information transfer

The writing and reading of AAL-user information into and out of cell payloads by the AAL adopts a First-In First-Out (FIFO) convention. This convention coupled with the assumption of sequential integrity of information transfer by the ATM layer (i.e. cell sequence integrity) preserves the sequential integrity of AAL-user information.

### 1) *At the sending AAL-entity during cell payload assembly*

The first bit (octet) received from the AAL user for the cell payload is assigned to the payload bit (octet) position nearest the cell header reserved for AAL-user information. The other bits (octets) received from the AAL user are sequentially assigned to payload bit (octet) positions in ascending order until the highest payload bit (octet) position reserved for AAL-user information is filled.

### 2) *At the receiving AAL-entity during cell payload disassembly*

The bits (octets) of AAL-user information in a cell payload are passed to the AAL user sequentially in ascending order beginning with the bit (octet) of AAL-user information occupying the payload bit (octet) position nearest the cell header.

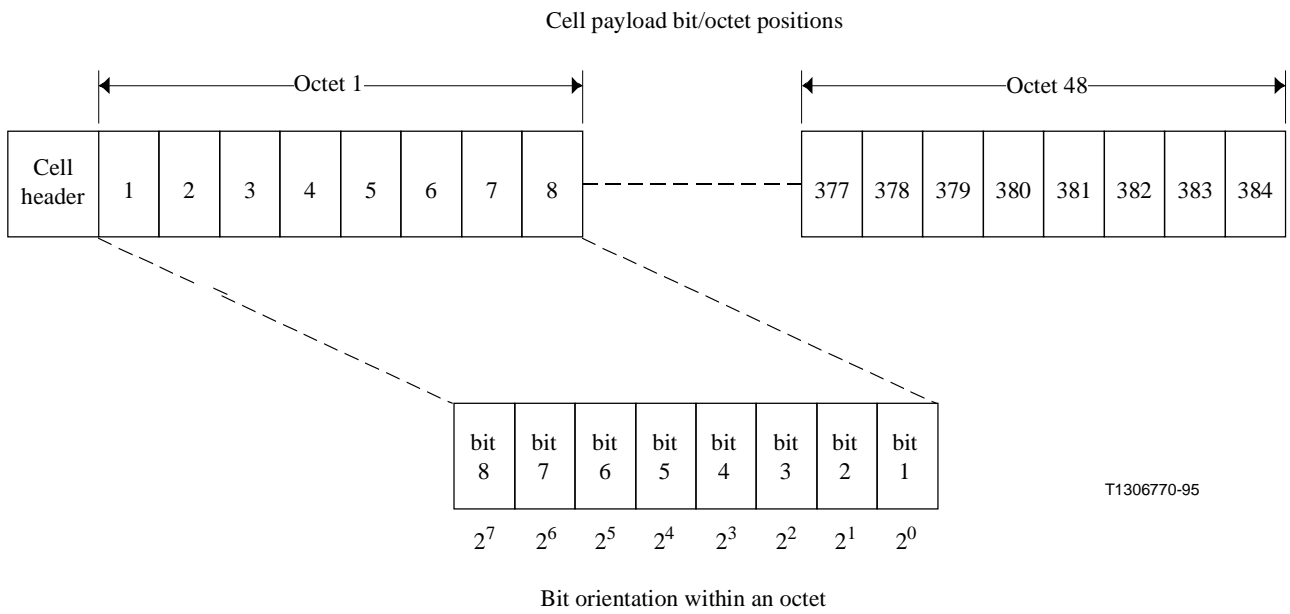
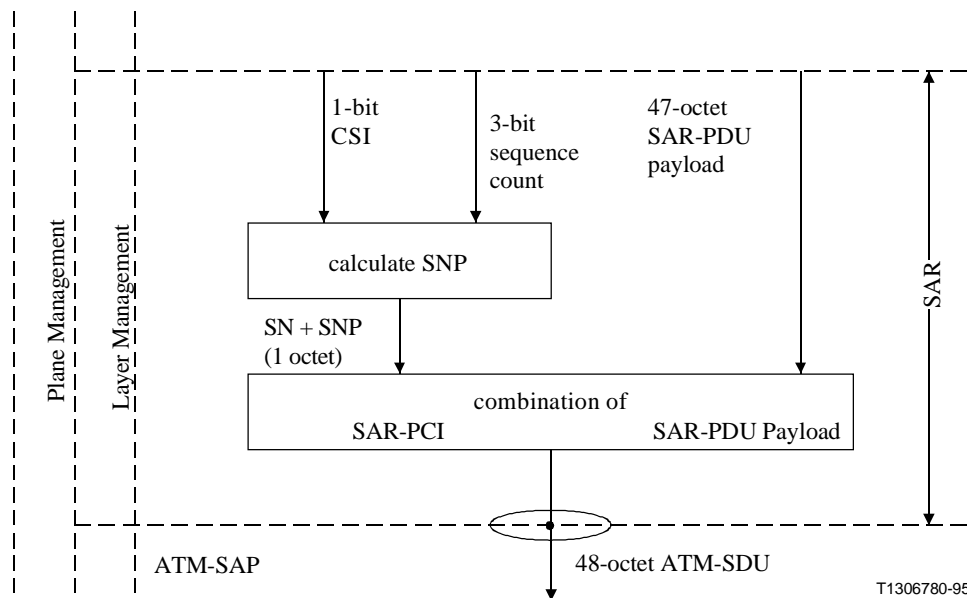

**Figure C.1/I.363.1 – Encoding principles**

## APPENDIX I

### Functional model and SDL of AAL type 1

#### I.1 Functional model of the SAR



**Figure I.1/I.363.1 – Functional model of the SAR at the transmitting side**

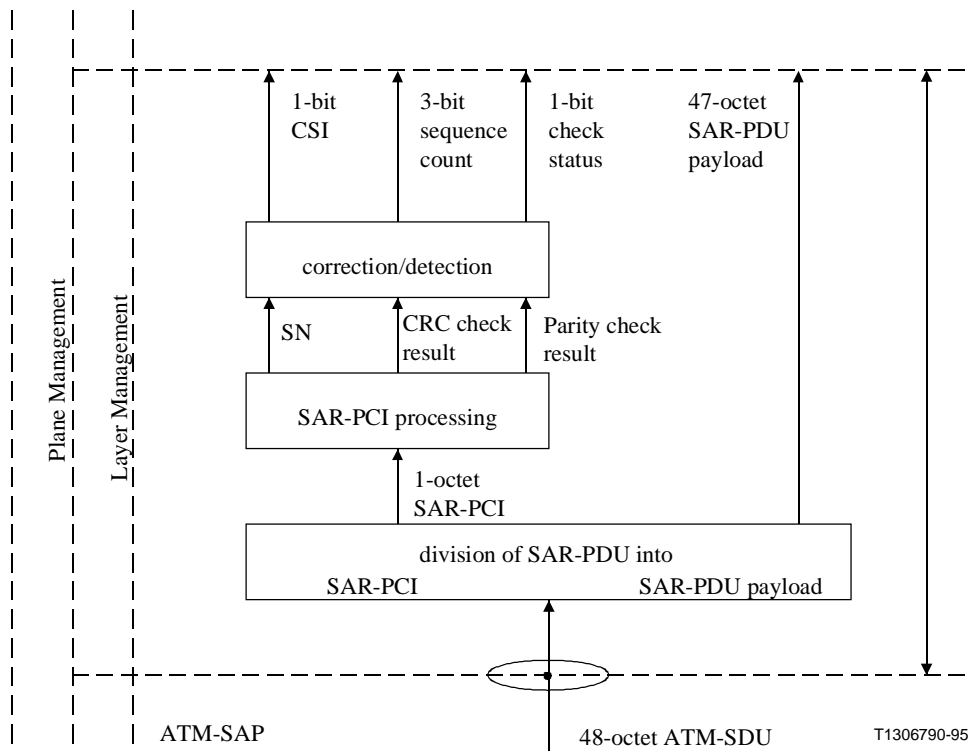

**Figure I.2/I.363.1 – Functional model of the SAR at the receiving side**

## I.2 SDL of the SAR

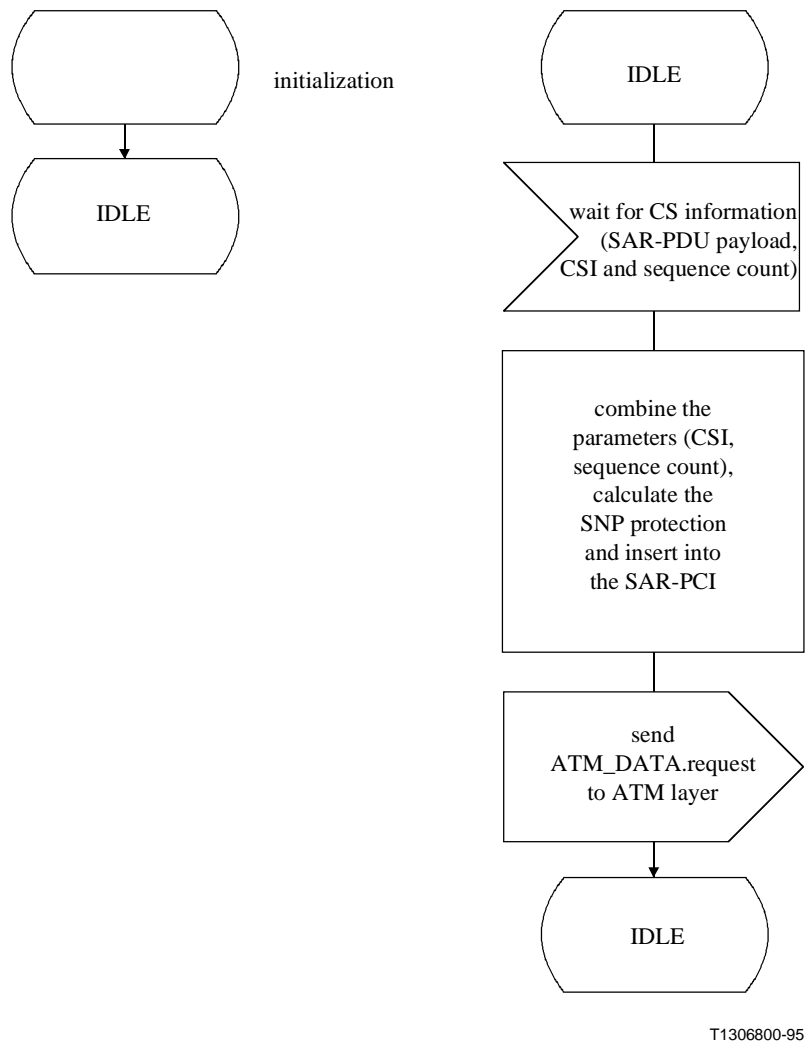
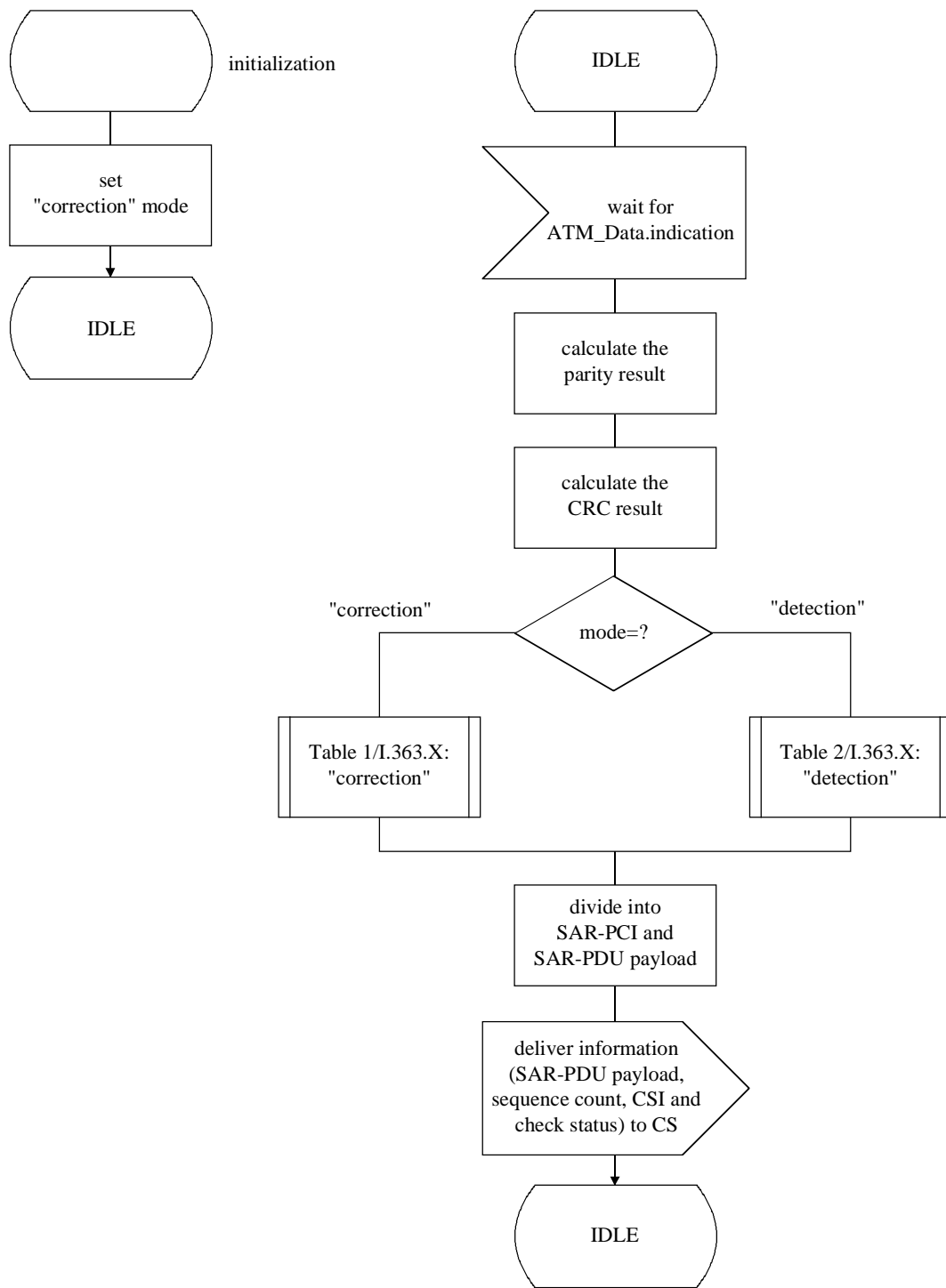

Figure I.3/I.363.1 – SDL of SAR transmitter



T1306810-95

**Figure I.4/I.363.1 – SDL of SAR receiver**

## APPENDIX II

### Informative and example parameters for AAL type 1 protocol

In order to facilitate further work on a detailed procedure description for a specific higher layer, this appendix gives informative and example parameters, i.e. a set of procedures and options, for some specific AAL type 1 services. It should be noted that:

- 1) the following description is intended to give informative material only;
- 2) not all AAL type 1 services are listed;
- 3) the use of parameters other than those described is not precluded; and
- 4) use of certain parameters is not illustrated.

Further detailed parameters can be defined, where necessary and appropriate, with respect to a specific higher layer in an associated Recommendation.

#### II.1 Circuit transport

##### II.1.1 Transport of digital channel supported by 64 kbit/s-based ISDN

###### a) *Transport of 64 kbit/s channel*

- CBR rate at AAL service boundary: 64 kbit/s
- Source clock frequency recovery: Synchronous
- Error correction method: Not used
- Error status indication at the receiver: Not used
- Pointer: Not used
- Partially fill cell method: Not used

###### b) *Transport of 384, 1536 or 1920 kbit/s channel*

- CBR rate at AAL service boundary: 384, 1536 or 1920 kbit/s
- Source clock frequency recovery: Synchronous
- Error correction method: Not used
- Error status indication at the receiver: Not used
- Pointer: Used (Note)
- Partially fill cell method: Not used

NOTE – Pointer is mandatory to support 8 kHz integrity for 64 kbit/s-based ISDN services at rates greater than 64 kbit/s, i.e. a demarcation of 6 (384 kbit/s), 24 (1536 kbit/s) and 30 (1920 kbit/s) octets per 125  $\mu$ s.

##### II.1.2 Transport of G.702 PDH circuit

For this example, it is important to distinguish the clock operation mode at the AAL service boundary, i.e. service clock, with respect to a network clock. Asynchronous circuit transport provides transport of signals from CBR sources whose clocks are not frequency-locked to a network clock. Synchronous circuit transport provides transport of signals from CBR sources whose clocks are frequency-locked to a network clock. Whether it is synchronous or asynchronous will depend on the service provided by the specific network.

- a) *Synchronous circuit transport*
- CBR rate at AAL service boundary: (Note 1)
  - Source clock frequency recovery: Synchronous
  - Error correction method: Not used
  - Error status indication at the receiver: Not used
  - Pointer: Not used
  - Partially fill cell method: Not used

NOTE 1 – Example bit rates are 1.544, 2.048, 6.312, 8.448, 44.736 and 34.368 Mbit/s as defined in Recommendation G.702.

- b) *Asynchronous circuit transport*
- CBR rate at AAL service boundary: (Note 2)
  - Source clock frequency recovery: Asynchronous (Note 3)
  - Error correction method: Not used
  - Error status indication at the receiver: Not used
  - Pointer: Not used
  - Partially fill cell method: Not used

NOTE 2 – Example bit rates are 1.544, 2.048, 6.312, 8.448, 44.736 and 34.368 Mbit/s as defined in Recommendation G.702.

NOTE 3 – There are two clock recovery methods for asynchronous circuit transport, adaptive clock or SRTS method. The adaptive clock method supports circuit transport application where control of wander can be relaxed (see 2.5.2.2.1). The SRTS method supports circuit transport application where control of jitter and wander is necessary (see 2.5.2.2.2). The need to control wander is not determined solely by the applications supported, but also by the points of AAL connection termination (i.e. CPE to CPE termination, network to network termination, CPE to network termination).

### II.1.3 Transport of G.709 SDH circuit

This example illustrates circuit transport of G.709 SDH signals.

- *Transport of TU-11, TU-12 or TU-2*
- CBR rate at AAL service boundary: 1728, 2304 or 6912 kbit/s
  - Source clock frequency recovery: Synchronous
  - Error correction method: Not used
  - Error status indication at the receiver: Not used
  - Pointer: Used (Note)
  - Partially fill cell method: Not used

NOTE – Pointer is mandatory to indicate V1 byte of TU-11, TU-12 or TU-2.

## II.2 Video signal transport

- a) *Distributive television services*

This example illustrates transport of distributive television signals encoded by using MPEG2 with a constant bit rate, as described in Recommendation J.82.

- CBR rate at AAL service boundary: Depending on MPEG2 parameters
- Source clock frequency recovery: Asynchronous (Note 1)

- Error correction method: Used (procedure of 2.5.2.4.2) (Note 2)
- Error status indication at the receiver: Used
- Pointer: Not used
- Partially fill cell method: Not used

NOTE 1 – The adaptive clock method is used (see 2.5.2.2.1).

NOTE 2 – This method can perform correction of, i.e. 4 cell losses within 128 cells. Detailed performances are given in 2.5.2.4.2.

b) *Conversational services of bit rates higher than primary rates*

This example illustrates transport of interactive video signals for, i.e. videotelephony and conference application, as specified in Recommendation H.310.

- CBR rate at AAL service boundary: Depending on H.310 parameters
- Source clock frequency recovery: Synchronous/Asynchronous per Recommendation H.310
- Error correction method: Used or not used per Recommendation H.310 (Note 3)
- Error status indication at the receiver: Used or not used per Recommendation H.310
- Pointer: Not used
- Partially fill cell method: Not used

NOTE 3 – No error correction method is used in an error free environment or a situation where a higher layer does not need correction of cell losses and/or bit errors. Error correction methods as described in 2.5.2.4 may be used in an error prone environment or a situation where a higher layer needs correction of cell losses and/or bit errors.

c) *Conversational services of  $p \times 64$  kbit/s signals*

This example illustrates transport of interactive video signals of the  $p \times 64$  videotelephony and videoconference applications as specified in Recommendation H.320.

- CBR rate at AAL service boundary: 384, 1536 or 1920 kbit/s (Note 4)
- Source clock frequency recovery: Synchronous
- Error correction method: Used or not used (Note 3)
- Error status indication at the receiver: Not used
- Pointer: Not used (Note 5)
- Partially fill cell method: Not used

NOTE 4 – The example bit rates are those supported in the 64 kbit/s-based ISDN by using H0, H11, H12, respectively.

NOTE 5 – Recommendation H.221, as a part of Recommendation H.320, provides bit-by-bit synchronization; hence, it does not need the support of 8 kHz integrity.

### II.3 Voiceband signal transport

This example illustrates transport of 64 kbit/s A-law or  $\mu$ -law coded Recommendation G.711 signals.

- CBR rate at AAL service boundary: 64 kbit/s
- Source clock frequency recovery: Synchronous
- Error correction method: Not used
- Error status indication at the receiver: Not used



- Pointer: Not used
- Partially fill cell method: Not used

NOTE – Care should be taken to minimize delay at the receiver for alleviating echo performance problems. See 2.5.1.3 for a detailed description.

## APPENDIX III

### **Informative and example operations for handling of lost/misinserted cells and for maintaining bit count integrity**

#### **III.1 Introduction**

This appendix provides informative examples for handling lost/misinserted cells and for maintaining bit count integrity. The material in this appendix is informative and should not be construed as mandatory implementation requirements.

Subclause III.2 gives two algorithms for SN processing. Both algorithms detect lost cells. In addition, one algorithm detects misinserted cells while the other algorithm imposes no inherent processing delay and is thus suitable for delay-sensitive applications. Both algorithms have to be supplemented by mechanisms to maintain bit-count integrity for the replacement of lost information, i.e. via dummy cells.

Subclause III.3 provides mechanisms that maintain bit-count integrity and have a limited ability to detect lost/misinserted cells. They do not impose an inherent delay exceeding the nominal CDV. In order to be able to use these mechanisms without any supplementary SN processing, the CDV must be small compared with the minimum cell inter-arrival time. For the transport of delay sensitive signals such as 64 kbit/s voiceband signals, the use of these SN processing algorithms must not introduce additional delay.

Some AAL services, such as voiceband signal transport (see 2.5.1.3), must accommodate a sudden increase or decrease in the nominal cell transfer delay which might result, for example, from a protection switching event. The handling of such a change in cell transfer delay is possible by enhancing the mechanisms described in this appendix but is not addressed.

#### **III.2 Sequence number processing**

##### **III.2.1 General**

Examples of algorithms for the processing of the Sequence Number in AAL type 1 are given. Two different algorithms are described: a robust algorithm, in which the decision to accept a cell is taken after the arrival of the next cell; and a fast algorithm, in which the decision to accept the cell is taken immediately after arrival of the cell. Potential problems due to the delay in waiting for the next cell, which arise with low bit rate services, are avoided by the fast SN algorithm. On the other hand, the robust algorithm is able to distinguish between lost and misinserted cells and thus may be more useful for applications which are sensitive to misinserted cells.

##### **III.2.2 Indications from the SAR sublayer**

The SAR sublayer provides the following inputs to the CS, concerning the SN field:

- a) the value of the SC (3 bits);
- b) the value of the CS indication (CSI) in the SN field (1 bit);
- c) the check status (valid or invalid) of the SN field.

Only indications a) and c) are used by the algorithms to determine lost/misinserted cells.

### III.2.3 Capabilities of the algorithm

Both algorithms have the following capabilities:

- detect a maximum of 6 consecutive lost cells;
- do not unnecessarily discard a cell with an invalid SN field.

In addition, the robust SN algorithm identifies and discards a single misinserted cell.

### III.2.4 The algorithms

A simplified comparison of the two algorithms is given in Figure III.1. The algorithms are described by a common state machine with five states, as shown in Figure III.2. An evolution in the state machine is indicated by an arc, on which there are two distinct values represented. The first value refers to the event that originates the evolution in the state machine, and the second value refers to an action to be taken as a result of the event.

#### III.2.4.1 Robust SN algorithm

A decision in this algorithm is taken after the analysis of two consecutive SNs. This means that when a cell is received, it is stored, waiting for the next one before it is eventually passed to the final destination. In the state machine, the action always refers to the stored cell.

A valid SN is defined as an SN which has no detected errors or had an error that was corrected.

The details of the algorithm are the following:

a) **START**

It is the initial state. It remains in this state discarding the cells until there is a valid SN.

b) **OUT OF SYNC**

In this state, the sequence counting is not synchronized yet. It waits for an SC that is in sequence with the previous one. When it occurs, the stored cell is accepted by the system. If a cell with an invalid SN is received, the system returns to START and the stored cell is discarded;

c) **SYNC**

In this state, the sequence counting is considered to be synchronized:

- If the SC is in sequence with the previous one, it remains in this state and the stored cell is accepted.
- If the SN is invalid, it goes to INVALID, but the stored cell is accepted.
- If the SC is not in sequence with the previous one, it goes to OUT OF SEQUENCE, accepting the stored cell.

d) **INVALID**

In this state, the system shall take a decision on the stored cell with the invalid SN, when it receives the next cell:

- If the SN is again invalid, the system returns to START and the stored cell is discarded.
- If the SN is valid and the SC is in sequence with the last cell received with a valid SN, the system returns to SYNC, but the stored cell is considered to be misinserted and it is discarded.
- If the SN is valid but the SC has a value exceeding by two the SC of the last cell received with a valid SN, it is assumed that although there was an invalid SN the stored cell is in sequence and therefore it is accepted. It returns to SYNC.

- If the SN is valid but is not in any of the previous situations, it discards the stored cell and goes to OUT OF SYNC.

e) **OUT OF SEQUENCE**

In this state the following actions are taken when a cell arrives:

- If the SN is invalid, it discards the stored cell and it goes to START.
- If the SN is valid and the SC is in sequence with the last cell received prior to the stored one, the system returns to SYNC, but the stored cell is considered to be misinserted and is discarded.
- If the SN is valid and the SC is in sequence with the SC of the stored cell, the system assumes that cells were lost; it inserts a number of dummy cells identical to the number of lost cells, accepts the stored cell and returns to SYNC.
- If the SN is valid and the SC has a value exceeding by two the SC of the last cell received prior to the stored cell, the system assumes that the stored cell was in sequence (i.e. the SN error protection mechanism failed) and therefore it accepts the stored cell and returns to SYNC.
- If the SN is valid but is not in any of the two previous situations, it discards the stored cell and goes to OUT OF SYNC.

### III.2.4.2 Fast SN algorithm

A decision in this algorithm is taken immediately after the analysis of the received cell. This means that when a cell is received, the SN is immediately evaluated and the cell is eventually passed to the final destination. In the state machine, the action always refers to the last cell received.

A valid SN is defined as an SN which has no detected errors or it had an error that was corrected.

The details of the algorithm are the following:

a) **START**

It is the initial state. It remains in this state discarding the cells until there is a valid SN.

b) **OUT OF SYNC**

In this state, the sequence counting is not synchronized yet. It waits for an SC that is in sequence with the previous one. When it occurs, the received cell is accepted by the system. If a cell with an invalid SN is received, the system returns to START and the received cell is discarded.

c) **SYNC**

In this state, the sequence counting is considered to be synchronized:

- If the SC is in sequence with the previous one it remains in this state and the received cell is accepted.
- If the SN is invalid, it goes to INVALID, but the received cell is accepted.
- If the SC is not in sequence with the previous one, it goes to OUT OF SEQUENCE, accepting the received cell.

d) **INVALID**

In this state, the system shall take the following decisions on the received cell:

- If the SN is again invalid, the system returns to START and the received cell is discarded.

- If the SN is valid and the SC is in sequence with the last cell received with a valid SN, the system returns to SYNC, but the received cell is discarded to keep bit-count integrity because the previous cell is considered to be misinserted but is already sent.
- If the SN is valid and the SC has a value exceeding by two the SC of the last cell received with a valid SN, it is assumed that although there was an invalid SN, the received cell is in sequence and therefore it is accepted. It returns to SYNC.
- If the SN is valid but is not in any of the previous situations, it discards the received cell and goes to OUT OF SYNC.

e) OUT OF SEQUENCE

In this state the following actions are taken when a cell arrives:

- If the SN is invalid, it discards the received cell and it goes to START.
- If the SN is valid and the SC is in sequence with the last cell received with a valid SN, the system returns to SYNC, but the received cell is considered to be misinserted and is discarded to keep bit-count integrity because the previous cell is considered to be misinserted but is already sent.
- If the SN is valid and the SC is in sequence with the SC of the previous cell, the system assumes that cells were lost; it inserts a number of dummy cells identical to the number of lost cells, accepts the received cell and returns to SYNC.
- If the SN is valid and the SC has a value exceeding by two the SC value of the last cell received in sequence (i.e. the SN error protection mechanism failed), the system assumes that the received cell was in sequence and therefore it accepts the received cell and returns to SYNC.
- If the SN is valid but is not in any of the two previous situations, it discards the received cell and goes to OUT OF SYNC.

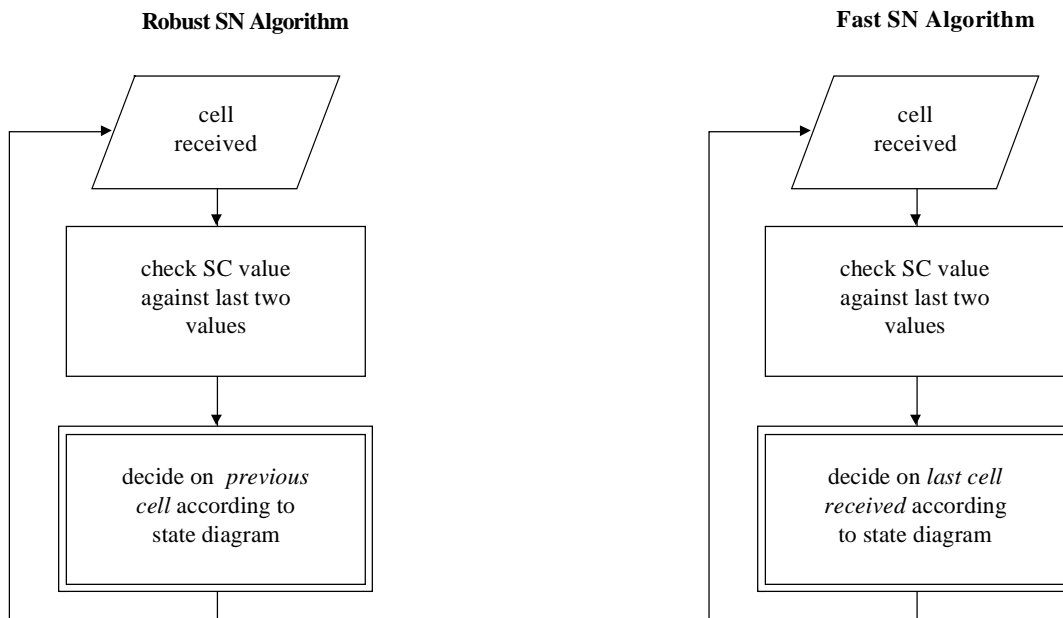

T1306820-95

**Figure III.1/I.363.1 – Differences between robust and fast SN algorithms concerning the actions performed at the state machine**

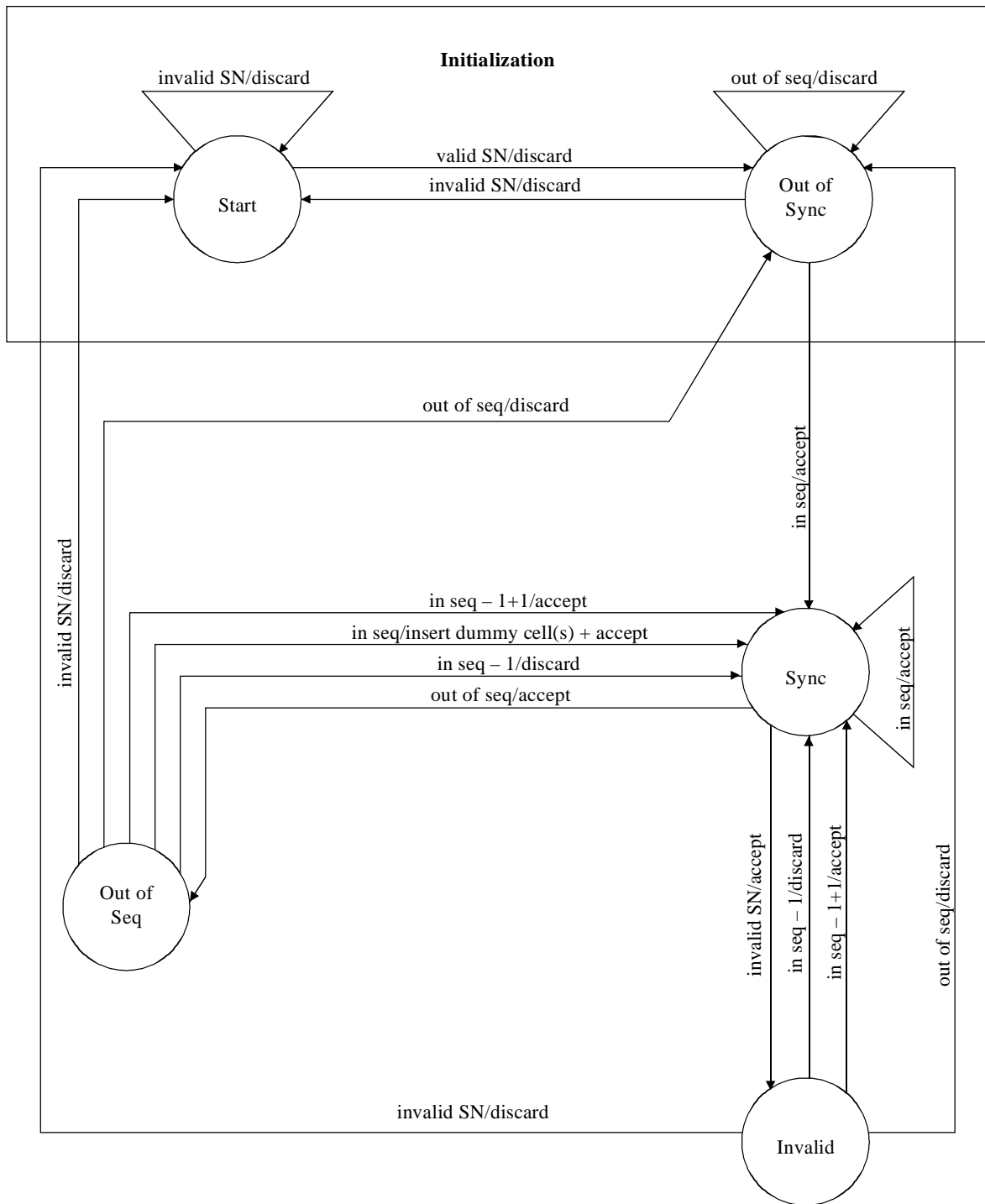

T1306830-95

**Figure III.2/I.363.1 – Informative and example algorithm state machine**

### III.3 Mechanisms to maintain bit-count integrity and basic handling of lost/misinserted cells

This subclause briefly describes two mechanisms: Cell Arrival Monitoring (CAM) and buffer-fill level monitoring. These algorithms provide some capability to detect lost and misinserted cells. They maintain bit-count integrity and impose a delay, in conveying user information across the AAL receiver, which is approximately equal to the CDV. They can be supplemented by either one of the SN processing algorithms described previously in this appendix. For such joint operation, if an

expected cell arrives during the course of delivering dummy bits/octets to the AAL user, appropriate bits/octets from this cell can be used, subsequently resulting in less loss of information.

For specific delay sensitive applications such as the transport of 64 kbit/s voiceband signals, these mechanisms may be used without any SN algorithms or with the fast SN algorithm described above. For specific delay-sensitive applications, joint operation with other algorithms – which, like the fast SN algorithm, do not introduce additional delay – is also possible. Such joint operation may be useful for connections for which it is difficult to establish a tight CDV bound.

### **III.3.1 Buffer-fill level monitoring**

The buffer associated with the individual connection has to be monitored. In the case of buffer underflow, which can, for example be the result of cell loss or cell discard, dummy bits/octets are inserted depending on the specific application. In the case of buffer overflow, i.e. a defined level of buffer fill is exceeded, bits/octets have to be discarded.

### **III.3.2 Cell Arrival Monitoring**

The AAL receiver may use a CAM technique. A time window of width determined by the nominal CDV is established around the expected arrival instant of the next cell. The first cell that arrives within the window is accepted. If no cell arrives within the window, dummy bits/octets are used upon expiration of the window.

## ITU-T RECOMMENDATIONS SERIES

Series A	Organization of the work of the ITU-T
Series B	Means of expression: definitions, symbols, classification
Series C	General telecommunication statistics
Series D	General tariff principles
Series E	Overall network operation, telephone service, service operation and human factors
Series F	Non-telephone telecommunication services
Series G	Transmission systems and media, digital systems and networks
Series H	Audiovisual and multimedia systems
<b>Series I</b>	<b>Integrated services digital network</b>
Series J	Transmission of television, sound programme and other multimedia signals
Series K	Protection against interference
Series L	Construction, installation and protection of cables and other elements of outside plant
Series M	Maintenance: international transmission systems, telephone circuits, telegraphy, facsimile and leased circuits
Series N	Maintenance: international sound programme and television transmission circuits
Series O	Specifications of measuring equipment
Series P	Telephone transmission quality, telephone installations, local line networks
Series Q	Switching and signalling
Series R	Telegraph transmission
Series S	Telegraph services terminal equipment
Series T	Terminals for telematic services
Series U	Telegraph switching
Series V	Data communication over the telephone network
Series X	Data networks and open system communication
Series Z	Programming languages